

**M520 series oscilloscope  
User's Guide  
Version 2.02**

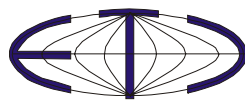

Copyright © 2004-2005 ETC s.r.o.

Thank you for choosing oscilloscope from M520 series, a product of ETC s.r.o. We believe it will fulfill your expectations. In order to assure that we will be able to provide you with up-to-date information, please fill-out the registration form at the ETC website.

For any further information or consultations, please contact us via mail, phone or preferably e-mail on the following adress:

Address:

ETC s.r.o.  
Rosinská cesta 8  
010 08, Žilina  
Slovak Republic

Phone:

+421-41-5652687

Fax:

+421-41-5652687

Internet:

URL: <http://www.etc.sk>  
e-mail: [support@etc.sk](mailto:support@etc.sk) - technical support  
[sales@etc.sk](mailto:sales@etc.sk) - sales  
[info@etc.sk](mailto:info@etc.sk) - other information

## Contents

Package contents .....	7
Warranty conditions .....	7
Software License Agreement .....	7
Precautions .....	8
1. Installation .....	9
1.1. Requirements .....	9
1.2. Hardware installation .....	9
1.3. Software installation .....	9
2. Hardware .....	10
2.1. Hardware description .....	10
2.1.1. Digital Shielding (DSH) .....	11
2.1.2. Trigger circuits .....	11
2.1.3. Data acquisition .....	13
3. Basic information .....	15
3.1. Front panel layout .....	15
3.2. Basic terms .....	15
4. Main window .....	16
4.1. Oscilloscope screen .....	16
4.2. Cursors and grid controls .....	18
4.3. Channel display controls .....	18
4.4. Display controls .....	18
4.5. Save/load controls .....	19
4.6. Zoom controls .....	20
4.7. Timebase controls .....	20
4.8. Trigger mode controls .....	21
4.9. Trigger controls .....	22
4.10. Vertical range controls .....	24
4.11. Vertical shifts controls .....	24
4.12. Signal source controls .....	25
4.13. Channel information .....	25
4.14. Main menu .....	26
4.14.1. Digital shielding window .....	27
4.14.2. Demo setup window .....	27
4.14.3. Color settings window .....	28
4.15. Special functions controls .....	28
5. Other functions .....	30
5.1. Print Support .....	30
5.1.1. Setting the name of a new layout .....	32
5.1.2. Layout Manager .....	32
6. Special functions .....	34
6.1. 80% function (80%) .....	34
6.2. Channel difference function (A-B) .....	34
6.3. Channel add function (A+B) .....	34
6.4. Channel A inversion (-A) .....	34
6.5. Channel B inversion (-B) .....	34
6.6. Channel A voltage inversion (-VA) .....	34
6.7. Channel B voltage inversion (-VB) .....	34

6.8. X-Y function (X/Y).....	35
6.9. Fourier transformation function (FT).....	36
6.9.1. Main menu .....	38
6.9.2. Complex filter window .....	40
6.10. Multiwave function (MW).....	41
6.10.1. Main menu .....	44
6.11. Inverse fourier transformation function (IFT) .....	45
6.12. Waveform parameters function (Wp).....	45
6.12.1. – Main menu .....	47
7. Performance characteristics .....	48
7.1. Vertical deflection system.....	48
7.2. Triggering .....	48
7.3. Data acquisition system .....	49
7.4. Probe compensation generator .....	49
7.5. Power .....	49
7.6. Mechanical characteristics .....	49
7.7. M521 timebase ranges .....	50
7.8. M522 timebase ranges .....	50
7.9. M523 timebase ranges .....	51
7.10. M524 timebase ranges .....	51
7.11. M525 timebase ranges .....	52
7.12. M526 timebase ranges .....	53

## Figures and tables

Fig. 2.1.2.1. – Block schematics of trigger circuits .....	11
Fig. 2.1.2.2. – Examples of trigger events (all inputs are enabled) .....	12
Fig. 2.1.3.1. – Simplified block schematics of the data acquisition .....	14
Fig. 3.1.1. – Front panel .....	15
Fig. 4.1. – Main window .....	16
Fig. 4.1.1. – Oscilloscope screen .....	17
Fig. 4.2.1. – The cursors and grid controls .....	18
Fig. 4.3.1. – Channel display controls .....	18
Fig. 4.4.1. – Display controls .....	19
Fig. 4.5.1. – Save/load controls.....	19
Fig. 4.5.2. – Load controls .....	19
Fig. 4.5.3. – Save controls.....	19
Fig. 4.6.1. – Zoom controls.....	20
Fig. 4.7.1. – Timebase controls.....	21
Fig. 4.8.1. – Trigger mode controls .....	21
Fig. 4.9.1. – Trigger controls .....	22
Fig. 4.9.2. – Trigger source controls.....	22
Fig. 4.9.3. – After trigger amount controls .....	23
Fig. 4.9.4. – Hold-off controls .....	23
Fig. 4.10.1. – Range controls .....	24
Fig. 4.11.1. – Vertical shift controls .....	24
Fig. 4.12.1. – Signal source controls.....	25
Fig. 4.13.1. – Channel information .....	25
Fig. 4.14.1.1. – Digital shielding window.....	27
Fig. 4.14.2.1. – Demo setup window .....	27
Fig. 4.14.3.1. – Color settings window .....	28
Fig. 4.15.1. – Special functions controls.....	28
Fig. 5.1.1. - Print Manager Window .....	30
Fig. 5.1.2. - Object Info.....	31
Fig. 5.1.3. - List of available objects.....	31
Fig. 5.1.1.1. - Specify Layout Name Window .....	32
Fig. 5.1.2.1. - Layout Manager Window.....	33
Fig. 6.8.1. – X-Y function window .....	35
Figure 6.9.1. – Fourier transformation window .....	36
Figure 6.9.2. – Status panel.....	37
Figure 6.9.3. – Information about harmonic selected by cursor .....	37
Figure 6.9.4. – Screen controls .....	38
Figure 6.9.2.1. – Complex filter window.....	40
Figure 6.9.2.2. – Selected frequency controls.....	41
Figure 6.9.2.3. – Frequencies controls.....	41
Figure 6.9.2.4. – New frequency window.....	41
Figure 6.10.1. – Multiwave function window.....	42
Figure 6.10.2. – Panel 1 .....	42
Figure 6.10.3. – Panel 2 .....	43
Figure 6.10.4. – Panel 3 .....	43
Figure 6.10.5. – Panel 4 .....	44
Figure 6.12.1. – Waveform parameters window.....	46

Table 7.1.1. – Vertical deflection system .....	48
Table 7.2.1. – Triggering .....	48
Table 7.3.1. – Data acquisition system .....	49
Table 7.4.1. – Compensation generator .....	49
Table 7.5.1. - Power .....	49
Table 7.6.1. – Mechanical characteristics .....	49
Table 7.7.1. – M521 timebase ranges .....	50
Table 7.8.1. – M522 timebase ranges .....	51
Table 7.9.1. – M523 timebase ranges .....	51
Table 7.10.1. – M524 timebase ranges .....	52
Table 7.11.1. – M525 timebase ranges .....	52
Table 7.12.1. – M526 timebase ranges .....	53

## Package contents

- oscilloscope EM52X – 1pc
- USB cable – 1pc
- installation leaflet – 1pc
- CD with software and user's guide in pdf – 1pc

## Warranty conditions

The ETC s.r.o. company guarantees reliable operation of the M520 oscilloscope in compliance with this documentation during a period of 24 months from the date of purchase.

Should a malfunction occur during the warranty period, excluding errors for which ETC can not be held responsible, ETC guarantees the repair of the product or its replacement with a new or repaired one free of charge.

The ETC company shall not be responsible for malfunctions on the device caused by an accident, incorrect manipulation, unauthorized interventions or similar.

When requesting the warranty service, the customer should send the device in its original package to the dealer from whom it was purchased or directly to the ETC company. The warranty certificate together with a description of the defect or malfunction should be included in the package. The customer agrees that a new or repaired product to be shipped would be insured against damage or loss during the transport and that he will cover the costs for the shipment and insurance.

## Software License Agreement

This legal document is an agreement between you, the end user, and ETC s.r.o. By installing this product on your computer, you are agreeing to become bound by the terms of this agreement and warranty conditions.

1. GRANT OF LICENSE. ETC s.r.o. as Licensor, grants you, the Licensee, a nonexclusive right to use and display this copy of the M520 software (hereinafter the "SOFTWARE"), this EM520 device and accompanying written materials, on a single COMPUTER at a single location and only together so long as you comply with the terms of this License.

2. OWNERSHIP. As the LICENSEE, you own the magnetic or other physical media on which the SOFTWARE is originally or subsequently recorded or fixed, but an express condition of this License is that ETC s.r.o. retains title and ownership of the SOFTWARE recorded on the original disk copy(ies) and all subsequent copies of the software, regardless of the form or media in or on which the original and other copies may exist. This License is not a sale of the original SOFTWARE or any copy.

3. COPY RESTRICTIONS. This SOFTWARE, EM520 device and accompanying written materials are copyrighted. Unauthorized copying or copy attempt of the EM520 device, including module which has been modified or included with any other system, or of written materials is expressly forbidden. It is, however, allowed to pass SOFTWARE on as the DEMO version. You may be held legally responsible for any copyright infringement which is caused or encouraged by your failure to abide by the terms of this License.

4. **DISCLAIMER OF THE WARRANTY OF ANY KIND CONCERNING SOFTWARE.** This SOFTWARE and accompanying written materials are provided "AS IS" without a warranty of any kind. Further, ETC s.r.o. does not warrant, guarantee or make any representations regarding the use, or the results of use, of the SOFTWARE, EM520 device or written materials in terms of correctness, accuracy, reliability, currentness, or otherwise. The entire risk as to the results and performance of the software is assumed by you.

## **Precautions**

Please follow these recommendations to avoid any possible problems that might occur while using the oscilloscope:

- read the User's Guide
- always connect device using cable, which is the part of package. If it is not possible, always use USB 2.0 cable.
- never connect signal with absolute voltage higher than 200V to measuring inputs. This value is valid for frequencies lower than 100kHz. Over this frequency, the voltage lowers with raising frequency. For example frequency 200kHz of 100V, 400kHz of 50V is the limit.
- never connect voltage lower than -10V and higher than +13V to the external triggering input (frequency lower than 20kHz). Over 20kHz, voltage lower than -0.5V or higher than +4V is not recommended.
- never connect voltage to the oscilloscope ground, it may result in device or computer damage
- never disassemble device, since there are no user serviceable parts inside



## 1. Installation

### 1.1. Requirements

Minimum configuration:

- PC PENTIUM compatible computer
- 32MB RAM
- CD-ROM
- VGA with resolution 800 x 600
- USB port 1.1
- mouse or other tracking device
- at least 20MB free space on the hard drive
- MS Windows 98 SE, ME, 2000 or XP

Recommended configuration:

- PC PENTIUM compatible computer with speed of at least 800MHz
- 64MB RAM
- CD-ROM
- VGA with resolution at least 1024x768
- USB port 2.0
- mouse or other tracking device
- at least 20MB free space on the hard drive
- MS Windows 98 SE, 2000 or XP

### 1.2. Hardware installation

Connect one side of the cable to the computer, other one to the device. Proceed with the software installation.

---

**WARNING: Always use cable, which is the part of the package. Usage of the improper cable can disable communication with the computer.**

---

### 1.3 Software installation

The software and the device drivers are located on the enclosed CD. Insert the CD into the CD-ROM drive. Then follow the instructions of the setup program that should launch automatically. If the CD autorun is not enabled in your computer's settings, please run file *autorun.exe* from the CD.

## 2. Hardware

The information contained in this chapter will help you to understand the features of your oscilloscope.

### 2.1. Hardware description

The M520 series of dual channel digital storage USB oscilloscopes connect to the computer via USB. They are compatible with both USB 2.0 and USB 1.1. Measurement accuracy is achieved by the stability of the parts used together with the computing power of the computer. Calibration data are part of the HW, which makes it impossible to lose them (opposite to the calibration data located on the diskette). Therefore, it is possible to simply connect the hardware to any computer (via USB 1.1 or USB 2.0 interface). All you have to do is just installing the software.

The M520 series oscilloscopes allow user to measure waveforms using two independent channels with resolution of 8 bits and sensitivity from 10mV/div to 5V/div (80mVfs to 40Vfs) in 9 steps. One division of the oscilloscope screen contains 32 dots. Input impedance matches the oscilloscope standards therefore any regular oscilloscope probe (with minimum compensation range of 32pF) can be connected to the device. The software supports 1:1, 1:10, 1:100 and 1:1000 probes. AC or DC coupling and type of probe can be independently selected for each vertical channel. Any of the inputs can be grounded without disconnecting the probes from the measured system. Vertical track position can be controlled with accuracy of 1 pixel of the oscilloscope screen. Measurement can be triggered from the Channel A, Channel B and/or External trigger input. Trigger threshold can be set independently for each channel in the range of whole oscilloscope screen with resolution of one pixel. Threshold of the External trigger input is fixed to about 1.5V (TTL and CMOS compatible). The M520 series oscilloscopes have the dual level triggering system, which is closely described in chapter 2.1.2. Oscilloscope hardware offers data acquisition with maximum rate of 50, 100 or 200MS/s depending on the model. Therefore it is not possible to sample non-repetitive waveforms faster than every 20, 10 or 5ns (depending on the model). However, thanks to random sampling method, it is possible to sample repetitive waveforms with period of 200, 100 or 50ps (depending on the model), which corresponds with equivalent sampling rate of 5, 10 or 20GS/s. For displaying waveforms acquired using the random sampling method, the ETC company has developed system called WCD (Waveform Conformity Detection), which speeds up display of changes of measured waveform.

The oscilloscope hardware can acquire data in one universal mode.

- **Acquiring data before and after trigger with settable trigger position** displays waveform before and/or after trigger. The position of the trigger is settable by the user. In this mode the hardware of the oscilloscope starts data acquisition immediately after the start of measurement. The trigger event terminates the data acquisition after collection the data amount set by the user. Number of data acquired after trigger can be set from two to over 63000 samples. This is much more than the capacity of onboard data buffer. This feature allows to display waveform corresponding with capacity of onboard storage (4KS or 8KS for each channel depending on the model) before the trigger or waveforms after trigger delayed from

the occurrence of trigger up to 63000 samples in the length of capacity of onboard storage. The trigger position can be set to any place between these margins. The "Hold Off" timer allows the user to prevent the occurrence of a trigger event after the start of data acquisition. This feature allows to acquire proper amount of data before the trigger.

Each measuring channel of the M520 series oscilloscopes has its own AD converter. No channel multiplexing is used for dual channel operation.

### 2.1.1. Digital Shielding (DSH)

Digital Shielding removes interference asynchronous with the measured signal, and it does not affect frequency characteristics of the measured waveform. The only negative effect of DSH is longer time period of waveform stabilization. It is, however, very simple to turn the DSH off using the on-screen controls. The DSH efficiency level corresponds to DSH level factor that can be set to any value from 2 to 64. The higher the level you choose, the longer it takes to stabilize.

### 2.1.2. Trigger circuits



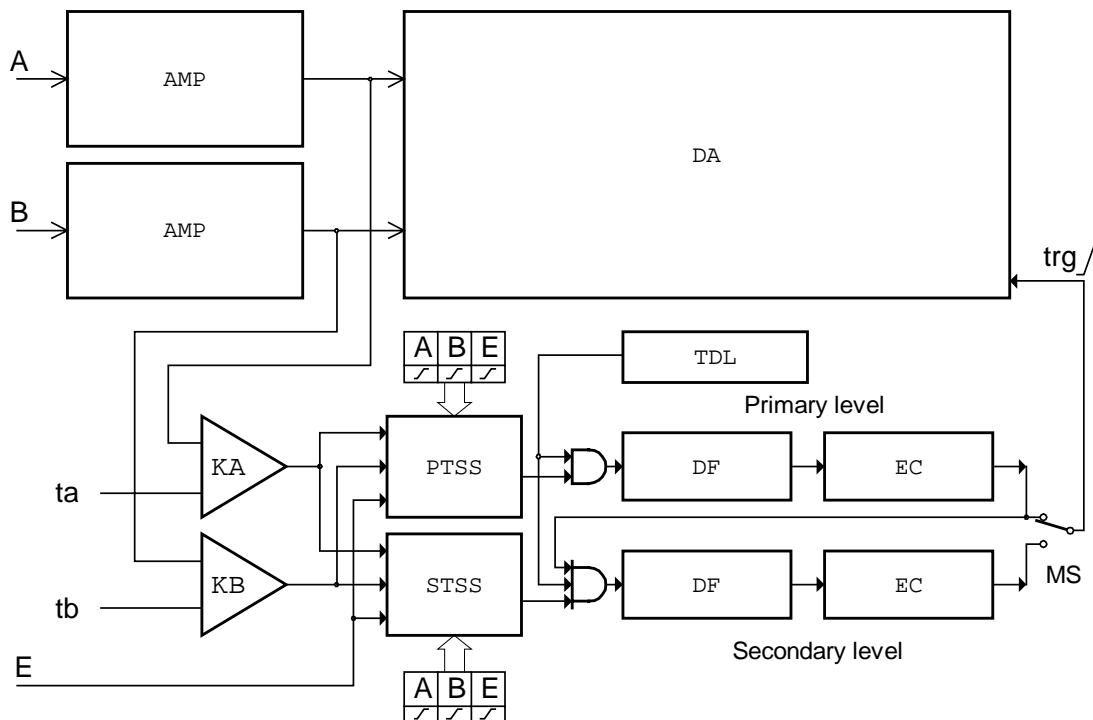















The block schematics of the dual level trigger circuits are shown on the figure 2.1.2.1.



**Fig. 2.1.2.1. – Block schematics of trigger circuits**

Data for trigger circuits come either from Channel A, Channel B or from external trigger input (E). The comparators KA and KB produce binary signals for Primary Trigger Source Selector (PTSS) and Secondary Trigger Source Selector (STSS) while the threshold of each comparator (ta, tb) can be set to any value in the vertical range. If the actual output voltage of the channel is higher than the actual threshold the output of comparator is set to 1 (TRUE). If it is lower than the threshold,

the output will be 0 (FALSE). The Trigger Source Selectors for each triggering level are independent. It is possible to select the source of triggering signal for each level independently. In addition to source selection, the PTSS and STSS can invert any of the input signal. The trigger event is generated with respect to change of the selector (PTSS, STSS) output signal from 0 (FALSE) to 1 (TRUE). Constant level of the signal cannot start the measurement. In case that only one of the signals is selected, trigger event is generated corresponding to the polarity, which is symbolically presented by direction of change of the signal. (0 to 1 means no inversion). When there are several inputs selected, the selector makes a logical addition (OR) of all of the selected inputs. Before adding the signals together, ones are adjusted with respect to the polarity settings. Trigger event is generated only when the change of result of the logical addition occurred from 0 to 1 (FALSE to TRUE). Logical values of the signals in the input of logical adder (OR) from which the trigger event is generated are created on the basis of following rules: value 0 (FALSE) is the value that selector input signal should have before valid trigger event. 1 (TRUE) is the value that this signal will have after the valid trigger event. For example, if triggering from Channel A is set to the trailing edge, then the output voltage of the channel is higher than the threshold voltage, consequent value on the adder input will be 0 (FALSE). Inverse situation will be taken as 1 (TRUE). Note that when using logical addition, all values must be 0 (FALSE) in order for result to be 0 (FALSE). It is relatively easy to find out which are the valid trigger events. Figure 2.1.2.2 shows several valid and invalid trigger events (all inputs are enabled).

				selected trigger event
	A	B	E	
				valid
				invalid
				invalid
				valid
				valid

**Fig. 2.1.2.2. – Examples of trigger events (all inputs are enabled)**

The digital pulse filters (DF) are implemented in both primary and secondary trigger levels. If activated, they filter out pulses shorter than the value  $4 \cdot N \cdot T_s$ , where  $T_s$  is the actual real time sampling period and  $N$  is the value set by the user ( $1 \leq N \leq 32767$ ). If we want to use this option it is necessary to set the valid trigger event to the end of the pulse. For example, if the pulse we want to filter off is positive (0 to 1 to 0) the trigger event should be set to trailing edge (1 to 0). If the pulse is inverse (1 to 0 to 1), the trigger event should be set to leading edge (1 to 0). The outputs of digital pulse filters are connected to event counters (EC). It counts the unfiltered pulses. If the MS switch is set to primary level, the output of primary event counter will change from 0 (FALSE) to 1 (TRUE) to indicate the valid trigger event after reaching the terminal count, which is user settable in the range of 1 to 32767. If the MS switch is set to secondary level, the output of primary event counter activates the

secondary trigger level. The input selector, digital filter and event counter can be set for secondary level independently to define the valid trigger event.

The trigger circuits of the series M520 DSOs are equipped with Hold Off timer (TDL). It blocks the triggering event for time period  $T=4*H*Ts$  from the start of data acquisition, where  $Ts$  is the actual real time sampling period and  $H$  is the user selectable value from 0 to 32767. It is important to set the proper value  $H$  to ensure that the hardware of the oscilloscope acquires proper amount of data before trigger event. For example, if we want to display waveform for time period of  $Tz$  before the trigger it is necessary to set  $T \geq Tz$  to ensure that all of the data will be displayed.

The M520 series oscilloscopes have four triggering modes implemented:

**AUTO** – Data acquisition is triggered by a valid trigger event. However, when after certain time the trigger event does not occur, measurement starts.

**NORMAL** – Data acquisition is triggered by a valid trigger event.

**SINGLE** – Data acquisition starts after activation from the control panel and it is synchronized by the valid trigger event. Just one measuring cycle is executed.

**MANUAL** – One measuring cycle is executed immediately after activation from the control panel.

### **2.1.3. Data acquisition**

The simplified block schematics of data acquisition is shown on Figure 2.1.3.1.

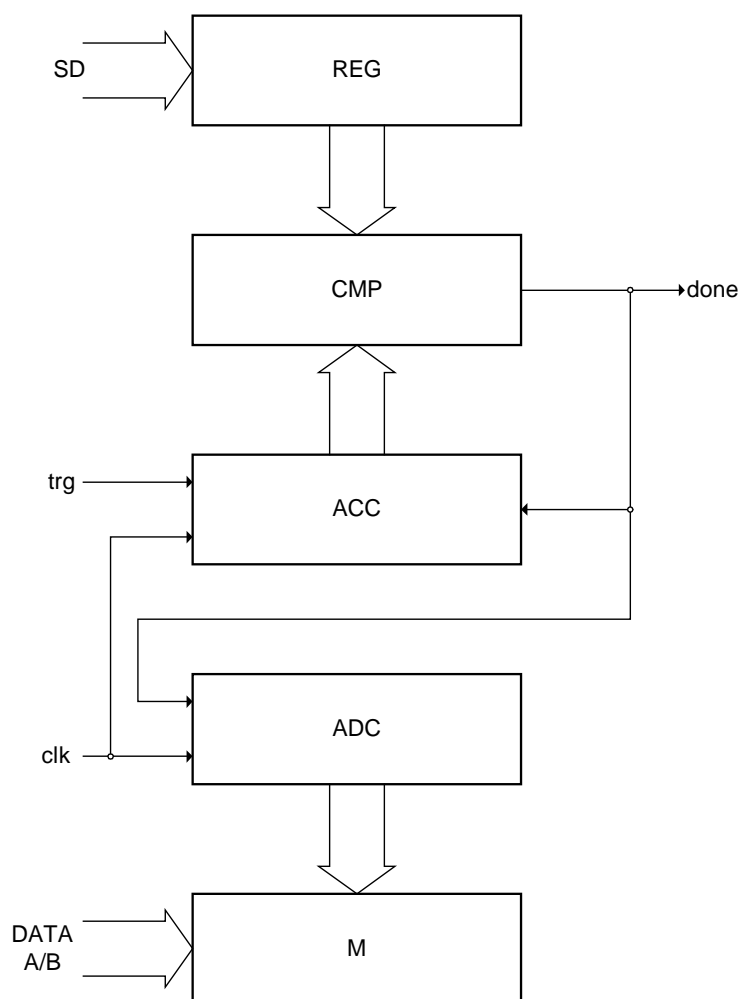

**Fig. 2.1.3.1. – Simplified block schematics of the data acquisition**

The data from AD converters are stored in the onboard memory M. This memory is addressed by address counter ADC, which starts to count immediately after start of measurement, regardless of trigger event. The occurrence of valid trigger event starts the after trigger data counter (ACC). Comparator CMP compares the state of ACC with the output of register (REG), which contains data amount acquired after trigger. When the output of ACC reaches the value written to REG, the comparator produces the signal (done), which stops both the ADC and ACC counters. The amount of data written after trigger to memory depends on the value of REG. The value written to REG controls the relation of the trigger event and the displayed data. Changing the value of REG it is possible to display data before, before and after or only after trigger. Because the length of the ACC counter is far more longer than the capacity of the onboard memory (more than 63000), it is possible to display data delayed from the trigger event more than the capacity of the onboard storage. However the length of displayed waveform is determined by the capacity of onboard memory. This structure of data acquisition creates the illusion of onboard memory with capacity determined by the length of ACC counter.

### 3. Basic information

#### 3.1. Front panel layout

Channel A, channel B, external synchronization input / compensation generator output and LED are accessible on the front panel.



*Fig. 3.1.1. – Front panel*

If the LED color is:

- green, the device is configured and there is no communication with a computer in this moment
- orange, the device communicates with a computer
- red, device is powered, but not configured

#### 3.2. Basic terms

This Chapter explains the basic terms used throughout the text.

**Click** – Position the mouse cursor over the chosen object. Then press and release the left mouse button.

**Double-Click** – Two successive clicks.

**Drag** – Position the mouse cursor over the object you want to move. Then press the left mouse button and hold it down. The chosen object moves with the mouse cursor. After releasing the mouse button the object moves to the new location.

**Enter the value into the edit box** – Click the edit box. Use the keyboard to enter the desired value and confirm pressing “Enter”.

**Insert the value into the edit box** – Click the edit box. Use the keyboard to enter the desired value.

**Set the value using the scroll bar** – It is possible to change a value by simply dragging the scroll bar slider. Clicking the arrows of the scroll bar increases or decreases the value by minimal steps. Clicking in between the slider and the arrows changes the value by larger steps.

**Select the value from the combo box** – Open the list of all possible values of the edit box by clicking it. Then set the desired value by clicking it.

## 4. Main window

The main window opens after the application starts. The controls in this window allows you to use most of the oscilloscope functions.

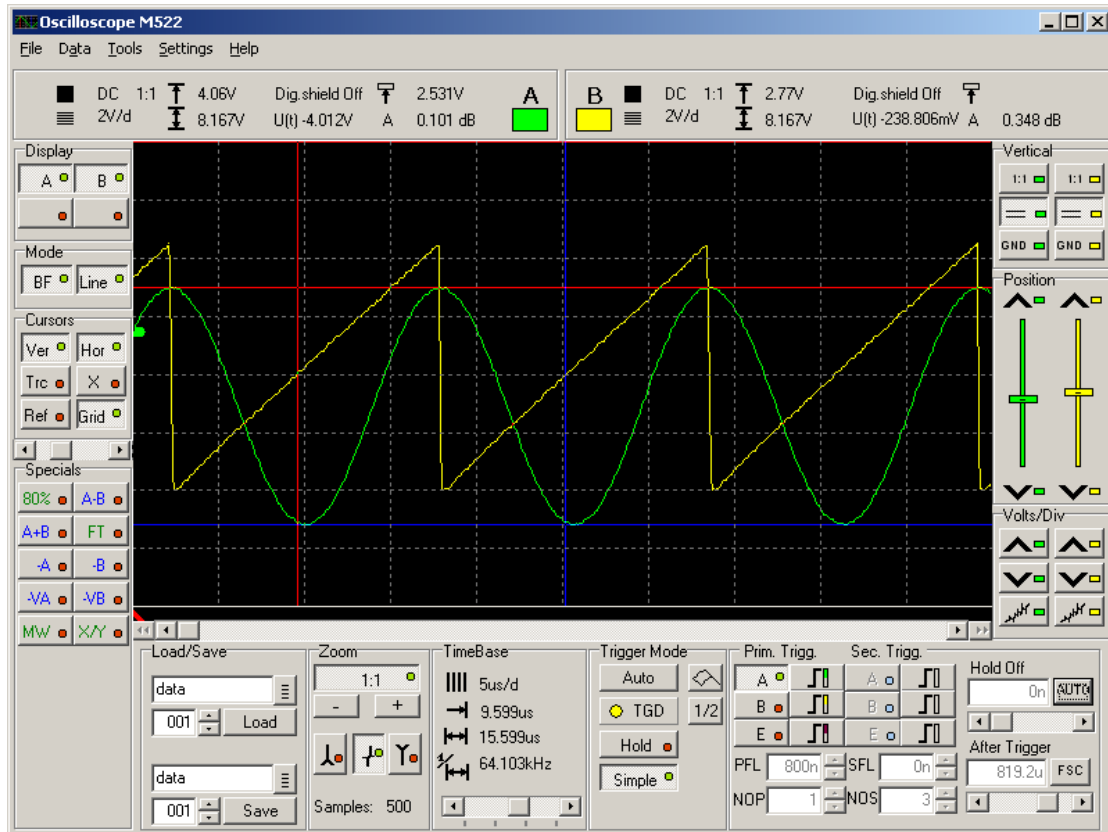

*Fig. 4.1. – Main window*

All controls connected to one of the channels have channel color.

---

**TIP: The channel color can be changed in main menu.**

---

### 4.1. Oscilloscope screen

The oscilloscope screen is located in the middle of the main window.



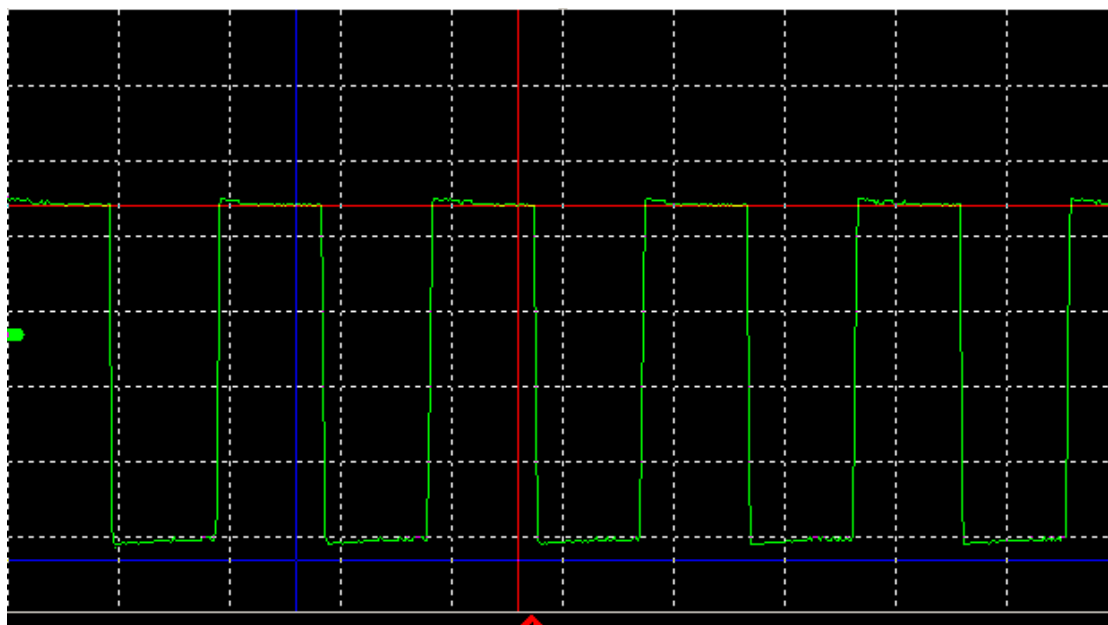

*Fig. 4.1.1. – Oscilloscope screen*

The oscilloscope screen is divided into 10 horizontal and 8 vertical divisions. The trigger event is marked with the red triangle located in the bottom of the screen. If the trigger event occurred before the displayed waveform, the arrow pointing left is drawn. If the trigger event occurred after the displayed waveform, the arrow pointing right is drawn.

---

**WARNING: The trigger mark position can slightly differ (especially when using fast timebase) from the real position of the trigger event.**

---

Two vertical, two horizontal cursors and one reference cursor can be activated. Vertical cursors have red (cursor 1) and blue (cursor 2) color by default. Horizontal cursors have red (cursor 1) and blue (cursor 2) color by default as well. Reference cursor has white color by default. The cursors and grid controls are described in chapter 4.2.

---

**TIP: The cursors color can be changed in main menu.**

---

You can move cursor by dragging it.

The waveform is drawn using the channel color. The default channel colors are following: Channel A green, channel B yellow, virtual channel (the one used for display of function result) C is purple and channel D is dark green. The channel controls are described in chapter 4.3.

---

**TIP: The channel colors can be changed in main menu.**

---

The threshold voltage mark is located in the left. You can change threshold voltage by dragging it.

## 4.2. Cursors and grid controls

The cursors and grid controls are located in the left part of the main window.



*Fig. 4.2.1. – The cursors and grid controls*

„Ver“ - activates/deactivates vertical cursors.

„Hor“ - activates/deactivates horizontal cursors.

„Ref“ - activates/deactivates reference cursor.

„Grid“ - activates/deactivates grid.

„Trc“ - activates/deactivates the Trace mode, where the cursors behave as follows:

- the cursor 2 behaviour is not affected
- while dragging cursor 1, the cursor 2 moves to maintain the distance between cursors

„X“ – activates/deactivates mode, where the drag of cursors intersection moves both cursors

The scrollbar adjusts grid brightness.

---

**TIP: The grid color can be changed in main menu.**

---

## 4.3. Channel display controls

The channel controls are located in the left of the main window.

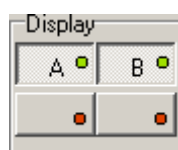

*Fig. 4.3.1. – Channel display controls*

„A“ – activates/deactivates channel A waveform

„B“ – activates/deactivates channel B waveform

The special function can be activated by click on the appropriate button (located in special functions box) followed by click on one of the buttons located in the bottom of the channel controls. Function results are displayed with the color of the selected virtual channel (left button is channel C, right one is channel D).

## 4.4. Display controls

The display controls are located in the left of the main window.



*Fig. 4.4.1. – Display controls*

„BF“ – activates/deactivates „Beam finder“ mode. When activated, the waveform exceeding vertical range is displayed as line on appropriate screen side.

„Line“ – activates/deactivates mode, where the sample is connected with adjacent one with line.

---

**TIP: The point size in “point” mode (deactivated “Line”) can be changed in main menu.**

---

## 4.5. Save/load controls

The save/load controls are located in the bottom of the main window.

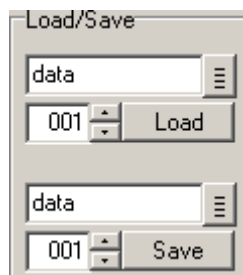

*Fig. 4.5.1. – Save/load controls*

The load controls are located in the panel top.

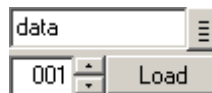

*Fig. 4.5.2. – Load controls*

The name of source file has to be inserted into the upper edit box. The file extension has to be inserted into the lower edit box.

The  button opens standard operating system dialog, where you can select source file.

Click „Load“ to load and display data.

---

**TIP: Change of any parameter affecting the data acquisition hides the loaded data.**

---



---

**TIP: The color used to display waveform can be changed in main menu.**

---

The save controls are located in the panel bottom.

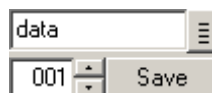

*Fig. 4.5.3. – Save controls*

The name of target file has to be inserted into the upper edit box. The file extension has to be inserted into the lower edit box (from 000 to 999). The extension is automatically incremented by one after the successful save.

The  button opens standard operating system dialog, where you can select target file.

Click „Save“ to save data.

## 4.6. Zoom controls

The zoom controls are located in the bottom of the main window.



*Fig. 4.6.1. – Zoom controls*

The amount of samples on the screen is displayed in the panel bottom. Click top button to activate/deactivate zoom.

---

**TIP: While scrolling the scrollbar (the one under the main screen) with zoom deactivated, two violet lines are drawn on the screen. These lines determine the part of waveform displayed with activated zoom.**

---

“-“ , “+” – change zoom factor

If there are more than 500 samples displayed on the screen, one displayed sample has to be calculated out of more than one measured sample. The samples are then displayed as follows in this case:

If the  button is activated, the displayed sample is calculated as average of the measured samples.

If the  button is activated, the displayed sample is calculated as a maximum of measured samples.

If the  button is activated, the displayed sample is calculated as a minimum of measured samples.

If both the  button and  button are activated, the line connecting measured sample with maximum and minimum value is displayed.

## 4.7. Timebase controls

The timebase controls are located in the bottom of the main window.

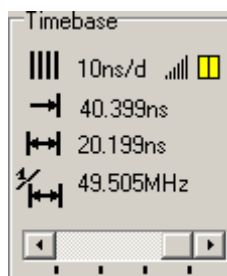

*Fig. 4.7.1. – Timebase controls*

You can change timebase using scrollbar located in the bottom.  
Following information are available:

- ▄ - time of one screen division
- - time between trigger event and vertical cursor 1
- ↔ - time between vertical cursors
- ↔ - frequency between vertical cursors

---

**WARNING: If the information about the time between trigger event and vertical cursor 1 has to be accurate (error smaller than 10ns), it is necessary to make following correction: measure time between trigger event mark and real trigger event and use this value to correct the information.**

---

If the sampling mode is activated, the  is displayed in the panel top right corner together with two rectangles reflecting the amount of samples acquired (left rectangle represents channel A, right one represents channel B):

- red – less than 50% samples are acquired
- yellow – more than 50% but less than 100% samples are acquired
- green – 100% samples are acquired

## 4.8. Trigger mode controls

The trigger mode controls are located in the bottom of the main window.



*Fig. 4.8.1. – Trigger mode controls*

Click button on the top left corner to switch between following trigger modes:  
„Normal“ – It produces sweep only when the trigger signal meets the threshold level and slope criteria.

„Auto“ – Measurement if repeatedly triggered. If the trigger event does not occur before timeout, the sweep free-runs without the trigger signal; otherwise it is triggered by trigger.

„Single“ – Single measurement. Starts by clicking on the  button. Sweep is produced only when trigger signal meets the threshold level and slope criteria.

„Manual“ – Single measurement. Starts by clicking on the  button. Sweep is produced regardless the trigger signal.

The „TGD“ indicator reflects the measurement state by changing its color:  
 red – the measurement has started, but the trigger event has not occurred yet  
 yellow – the measurement has started, trigger conditions met, but the data acquisition hasn't finished yet  
 green – the measurement has ended, the data are displayed on the oscilloscope screen

“1/2” – sets the trigger threshold to the middle between maximum and minimum value of the waveform.

“Hold” – pauses the measurement

“Simple” – switches trigger controls to/from simple mode. The secondary triggering level is deactivated, the trigger counter on primary level is set to one and a digital filter on the primary level is activated and set to minimum value in simple mode.

The checkbox “WCD” appears in sampling mode. This control activates/deactivates waveform conformity detection (WCD).

---

**TIP: If the device is not able to acquire 100% samples in usual time, we recommend you to deactivate WCD or change its sensitivity in main menu.**

---

## 4.9. Trigger controls

The trigger controls are located in the bottom of the main window.

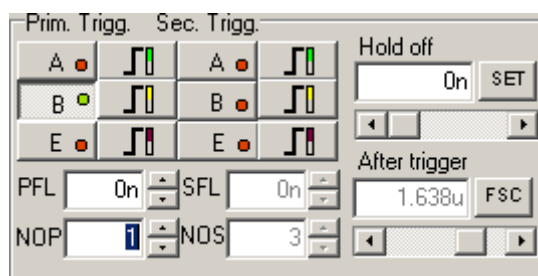

*Fig. 4.9.1. – Trigger controls*

The trigger source controls are located in the left.



*Fig. 4.9.2. – Trigger source controls*

Left buttons control primary level, the right ones control secondary level.

“A” – activates/deactivates channel A as triggering source

“B” – activates/deactivates channel B as triggering source

“E” – activates/deactivates triggering from external triggering input (E)



- switches between sensitivity on leading/trailing edge

You can enter required trigger event occurrences count into NOP (primary level) or NOS (secondary level) edit box. The count can be any value from 1 to 65535.

You can enter minimum length of trigger event considered as valid into PFL (primary level) or SFL (secondary level) edit box.

---

**TIP: You can use units in the PFL/SFL edit box (for example 45u is 45 microseconds). Valid units are: n – nano, u – micro, m – milli).**

---

The after trigger amount controls are located in the bottom right corner.

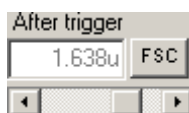

*Fig. 4.9.3. – After trigger amount controls*

The button in the right switches between following after trigger modes:

“HSC” – Half of the memory is acquired after, other half before trigger.

“FSC” – Whole memory is acquired after trigger. This, in fact, is the classic after trigger mode.

“MIN” – The amount of data acquired after trigger is set to minimal possible value (pure before trigger mode).

“SET” – The time acquired after trigger event can be set by entering value into the edit box or using scrollbar.

---

**TIP: You can use units in the edit box (for example 45u is 45 microseconds). Valid units are: n – nano, u – micro, m – milli).**

---

The hold-off controls are located in the top right corner.

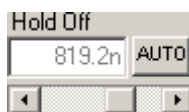

*Fig. 4.9.4. – Hold-off controls*

The button in the right switches between following hold-off modes:

“AUTO” – The hold-off time is set to guarantee acquisition of the whole memory.

“SET” – The hold-off time can be set by entering value into edit box or using scrollbar.

---

**TIP: You can use units in the edit box (for example 45u is 45 microseconds). Valid units are: n – nano, u – micro, m – milli).**

---

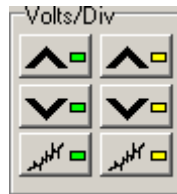

## 4.10. Vertical range controls

The vertical range controls are located in the right of the main window.



*Fig. 4.10.1. – Range controls*

Channel A controls are located in the left, channel B controls are located in the right.

-  - changes the range to less sensitive
-  - changes the range to more sensitive
-  - activates/deactivates digital shielding

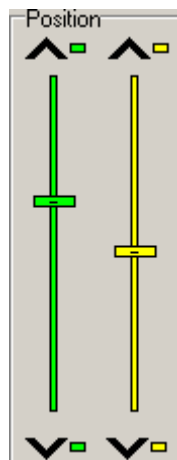

## 4.11. Vertical shifts controls

The vertical shift controls are located in the right of the main window.



*Fig. 4.11.1. – Vertical shift controls*

Channel A controls are located in the left, channel B controls are located in the right.

-  - the waveform is shifted upwards by smallest possible value
-  - the waveform is shifted downwards by smallest possible value

Click between slider and button to shift waveform by approx. 1 point on screen

The vertical shift can be set by dragging the slider as well.

---

**TIP: Keeping the mouse button pressed between slider and button results in shift by approx. 3 points per second.**

---



## 4.12. Signal source controls

The signal source controls are located in the right of the main window.

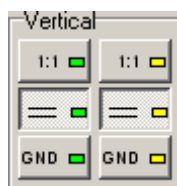

*Fig. 4.12.1. – Signal source controls*



Channel A controls are located in the left, channel B controls are located in the right.

“1:1”, “1:10”, “1:100” or “1:1000” – probe attenuation ratio

---

**WARNING: Selection of improper probe attenuation ratio may result in wrong information about voltages.**

---

Click  to select coupling. Click  to ground input. If the Single or Manual mode is activated or the measurement is paused (hold), the horizontal dotted line on the place of GND is displayed until at least one measurement is accomplished.

## 4.13. Channel information

The channel information are displayed in the top of the main window.

Channel A information are located in the left, channel B information are located in the right.

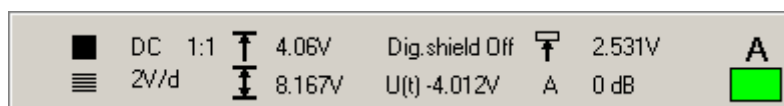

*Fig. 4.13.1. – Channel information*

Following information are displayed:

- - information about coupling and probe attenuation ratio
- ≡ - range
- ↑ - voltage between horizontal cursor 1 and reference cursor (reference cursor activated) or voltage between horizontal cursor 1 and 0V (reference cursor deactivated; this information is not displayed when coupling is set to AC)
- ⇄ - voltage between horizontal cursor 1 and 2

---

**WARNING: If the improper probe attenuation is set, the information will be inaccurate.**

---

„Dig. shield“ – indicates status of digital shielding

„U(t)“ – voltage between 0V and the intersection of vertical cursor 1 and waveform

 - trigger threshold voltage

“A” – ratio of the peak-peak voltage of the waveform on the screen and the voltage between horizontal cursors in decibels

Click rectangle located in the left or right to change channel color.

#### 4.14. Main menu

The main menu is located in the top of the main window. Following menu items are available:

*File / Print* – Opens print manager.

*File / Exit* – Closes application.

*Data / Export to clipboard / Voltage* – Exports waveforms to clipboard. Each value is in volts (or milivolts).

---

**WARNING: The export in volts can be inaccurate is used with AC coupling.**

---

*Data / Export to clipboard / Samples* – Exports waveforms to clipboard. Each value reflects quantization level of AD convertor (from 0 to 255).

*Data / Export to clipboard / Fixed units [V]* – Exports waveforms to clipboard. Each value is in volts.

*Data / Save as bitmap* – Saves main screen as picture in JPEG format.

*Tools / Generator* – Activates/deactivates compensation generator.

*Tools / Process licence file* – Processes selected licence file. If you purchase optional software, you will receive one from us. Once the licence file is successfully applied, all information is stored in the oscilloscope. Therefore, it is possible to use optional software with your oscilloscope on any computer without need to apply licence file.

*Settings / Restore defaults* – Reloads oscilloscope settings loaded on the application start.

*Settings / Save settings* – Saves oscilloscope settings to harddisk (to other file than default settings).

*Settings / Load saved settings* – Loads oscilloscope settings saved by selecting Settings | Save settings menu item.

*Settings / WCD sensitivity / Very high* – Sets very high WCD sensitivity.

*Settings / WCD sensitivity / High* – Sets high WCD sensitivity

*Settings / WCD sensitivity / Medium* – Sets medium WCD sensitivity

*Settings / WCD sensitivity / Low* – Sets low WCD sensitivity

*Settings / Digital shielding level* – Opens window, where you can select digital shielding level.

*Settings / Demo setup* – Opens window, where you can select signal parameters in demonstration mode.

*Settings / Dots mode / Large dots* – The large dots will be displayed, while the “line” mode is deactivated.

*Settings / Dots mode / Single dots* – The small dots will be displayed, while the “line” mode is deactivated.

*Settings / Color setup* – Opens window, where you can select colors.

*Settings / Tool tip help* – Activates/deactivates tool tip help.

*Help | Index* – Displays the Help index

*Help | ETC web* – Starts the internet browser installed in the computer to display the ETC's web site. This feature works only if the computer is already connected to internet.

*Help | Support* – Sends the e-mail message to the ETC's customer support. This feature works only if the computer has connection to internet.

*Help | About* – Displays information about product.

#### 4.14.1. Digital shielding window

The digital shielding window is opened after click on the main menu item.

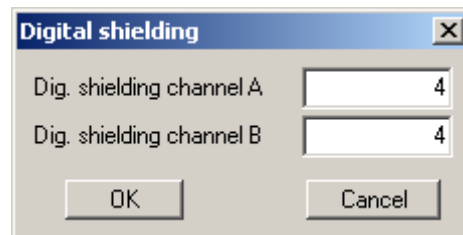

**Fig. 4.14.1.1. – Digital shielding window**

Enter the value to upper edit box to change digital shielding level for channel A or enter the value to lower edit box to change level for channel B. You can enter any value from 2 to 64. Digital shielding is activated by control located in the right of the main window.

---

**TIP: The higher digital shielding level is entered, the slower oscilloscope reflects signal change. We recommend to use level 4 for most measurements.**

---

Click “OK” to apply changes, click “Cancel” to discard them.

#### 4.14.2. Demo setup window

The demo setup window is opened after click on the main menu item.

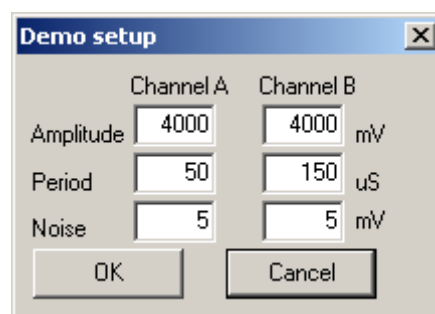

**Fig. 4.14.2.1. – Demo setup window**

Channel A controls are located in the left, channel B controls are located in the right.

“Amplitude” – amplitude of demo signal in mV

“Period” – period of demo signal in us

“Noise” – noise level in mV

### 4.14.3. Color settings window

The color settings window is opened after click on the main menu item.

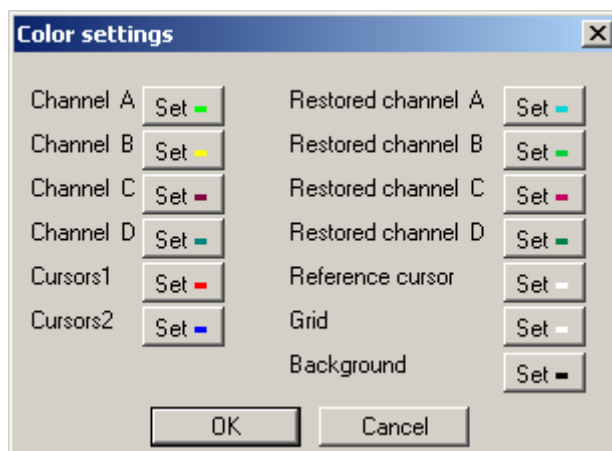

*Fig. 4.14.3.1. – Color settings window*

Click “Set” button located by the label to open standard operating system color dialog to change color of:

- “Channel A” – channel A controls
- “Channel B” – channel B controls
- “Channel C” – virtual channel C controls
- “Channel D” – virtual channel D controls
- “Loaded channel A” – loaded channel A controls
- “Loaded channel B” – loaded channel B controls
- “Loaded channel C” – loaded channel C controls
- “Loaded channel D” – loaded channel D controls
- “Cursor 1” – vertical and horizontal cursor 1
- “Cursor 2” – vertical and horizontal cursor 2
- “Reference cursor” – reference cursor
- “Grid” – grid
- “Background” – background

### 4.15. Special functions controls

The special functions controls are located in the lower left corner of the main window.



*Fig. 4.15.1. – Special functions controls*

Two function types exist:

1. Transformation functions, which display result on the main screen using virtual channel. These have blue color.
2. Other functions, which doesn't display result on the main screen. These have green color.

Click one of the transformation function button to half-activate it. After click on the desired virtual channel, the function is fully activated and the results are displayed with the color of the selected virtual channel.

Click one of the other function button to activate it.

You can find special functions description in chapter 6.

## 5. Other functions

### 5.1. Print Support

To open the print manager window, click the “Print” item of the [main menu](#).

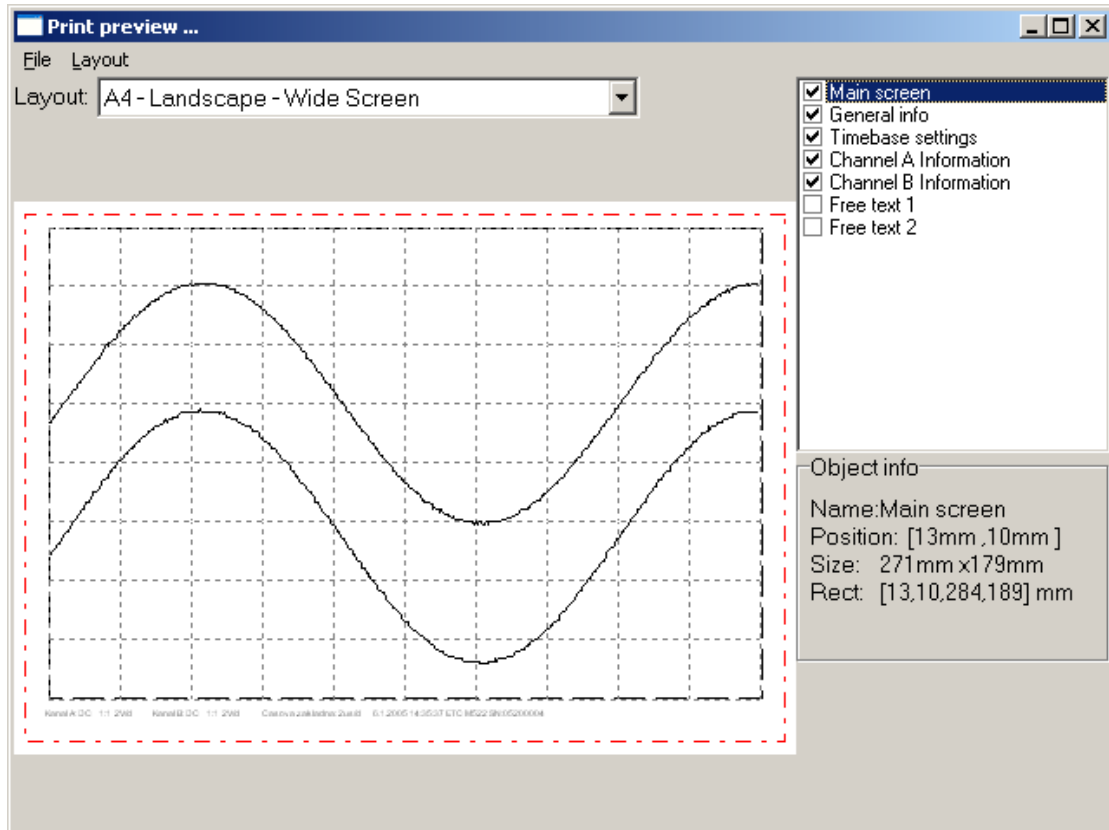

**Fig. 5.1.1. - Print Manager Window**

On the left side of the window the page is previewed as it will be printed. Several important parts of the page are highlighted. The lines marking these parts will not be printed. The red line outlines the printable area of the page. Selected object is marked by black dashed outline.

To select an object, click it. You can move it into a desired position by dragging it. To change the size of a chosen object, drag its outline.

In the lower right corner of the window the following information on the properties of the selected object is shown:

- “Name” – Name of the object
- “Position” – Coordinates of the upper-left corner of the object on the page in millimeters
- “Size” – Size of the object in millimeters
- “Rect” – Position of the upper-left corner and the lower-right corner on the page in millimeters

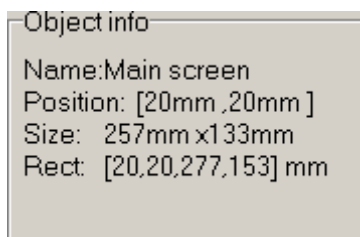

**Fig. 5.1.2. - Object Info**

In the upper-right corner of the window names of all the objects that can be placed into the page are listed. To display/hide an object, click the box next to the object name. To select an object, click the name of the object (if the object is displayed).

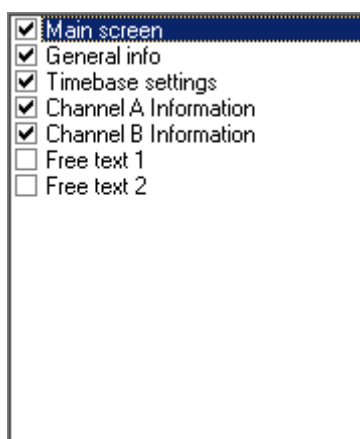

**Fig. 5.1.3. - List of available objects**

---

**TIP: Two objects with content that can be specified by the user are available (objects “Free text 1” and “Free text 2”). Double-clicking any of these objects opens a dialog window to insert the text to be displayed.**

---

It is possible to select automatic layout and predefined schemes of object display in the “Layout” combo-box. Choosing the “Custom” item does not affect the current layout.

---

**WARNING: In the “Layout” combo-box only the layouts available for the current paper size are shown.**

---

It is possible to save a modified layout under the current name choosing the “Layout / Save layout” item of the main menu of this window. To save it under a different name, choose “Layout / Save layout as”. A dialog box will appear to insert the name for the new layout.

Following are the other items Layout menu consists of:

- „Layout / Manage layouts” – Opens the Layout manager window.
- „File / Printer setup” – Opens the printer settings window

„File / Print“ – Prints the page

„File / Close“ – Terminates the print manager

### 5.1.1. Setting the name of a new layout

To open the Specify layout name dialog window, select the “*Layout / Save layout as*” item. Now you can enter the name of the new scheme.

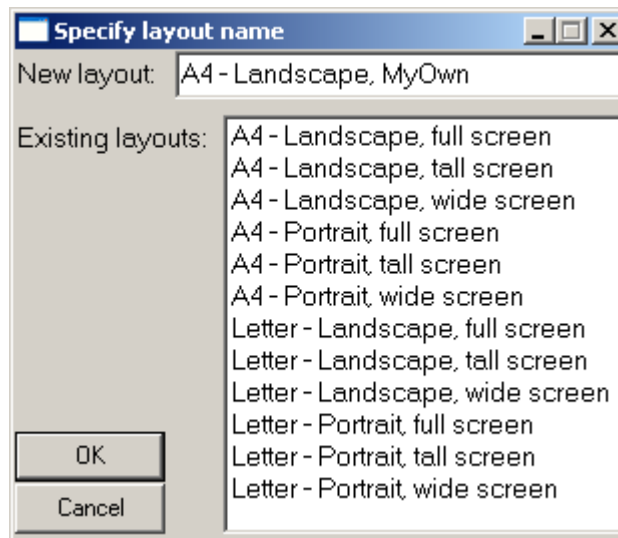

*Fig. 5.1.1.1. - Specify Layout Name Window*

It is necessary to insert a name of the new layout into the “New layout” box. This name has to differ from the names of the existing layouts. If the name would be identical with the name of another layout, this layout would be replaced by the new layout. At the same time the existing layout would be highlighted in the layout list. If you click a name of a layout in the list, this name will appear in the “New layout” box.

To save the layout, click the OK button.

### 5.1.2. Layout Manager

To open the Layout Manager window, select the “*Layout / Manage layouts*” item in the main menu of the print manager window.



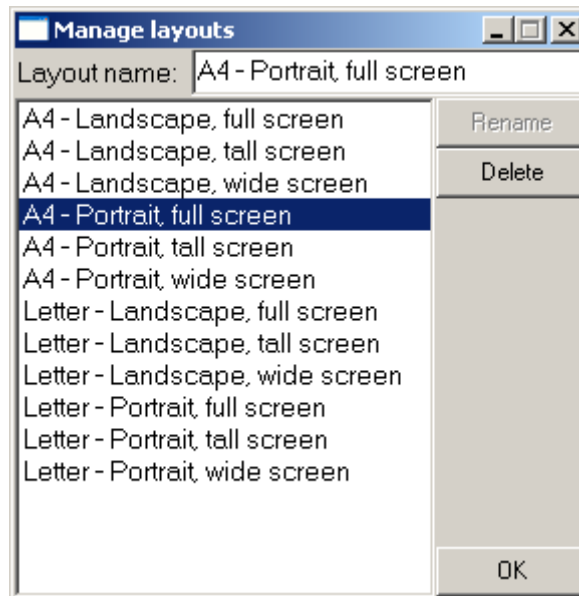

***Fig. 5.1.2.1. - Layout Manager Window***

To select a layout, double-click its name in the list.

To erase the selected layout, click the “Delete” button.

To rename a layout, select it, insert the new name into the “Layout name” box and then click the “Rename” button.

## 6. Special functions

### 6.1. 80% function (80%)

The horizontal cursors' positions are affected as follows:

Lower horizontal cursor is moved upwards by 10% of the distance between cursors and the upper one is moved downwards by same 10%.

### 6.2. Channel difference function (A-B)

The function result depends on the reference cursor state:

1. Reference cursor active: function calculates difference between the channel A and channel B, where the reference cursor level is considered to be zero. The result of the zero value is displayed on the reference cursor position.

2. Reference cursor inactive: function calculates difference of the channel A and channel B, where the 0V level is considered to be zero. The result of the zero value is displayed in the middle of the screen (between fourth and fifth division).

### 6.3. Channel add function (A+B)

The function result depends on the reference cursor state:

1. Reference cursor active: function adds channel A and channel B, where the reference cursor level is considered to be zero. The result of the zero value is displayed on the reference cursor position.

2. Reference cursor inactive: function adds channel A and channel B, where the 0V level is considered to be zero. The result of the zero value is displayed in the middle of the screen (between fourth and fifth division).

### 6.4. Channel A inversion (-A)

Function calculates inversion of the channel A (with no respect to 0V).

### 6.5. Channel B inversion (-B)

Function calculates inversion of the channel B (with no respect to 0V).

### 6.6. Channel A voltage inversion (-VA)

Function calculates channel A inversion, where the reference cursor position is considered as a zero value (reference cursor on) or the 0V is considered as a zero value (reference cursor off).

### 6.7. Channel B voltage inversion (-VB)

Function calculates channel B inversion, where the reference cursor position is considered as a zero value (reference cursor on) or the 0V is considered as a zero value (reference cursor off).

## 6.8. X-Y function (X/Y)

The X-Y function window is opened after an activation of the X-Y function.

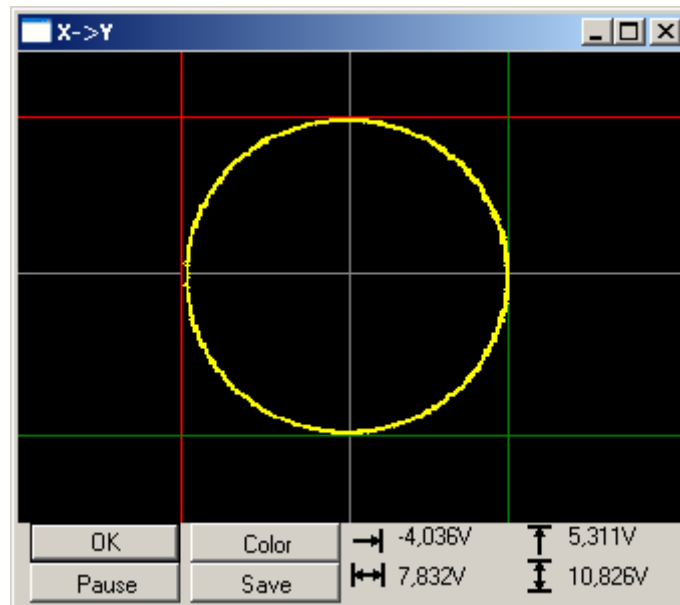

*Fig. 6.8.1. – X-Y function window*

---

**TIP: The X-Y function window stays always on top. Therefore it is possible to change oscilloscope settings and see their influence immediately.**

---

The 0V values for X-axis and Y-axis are displayed in gray color.

---

**TIP: The 0V positions can be changed by vertical shift for both axis.**

---

Two horizontal and two vertical cursors are available. Drag them to change their position.

---

**TIP: The X-Y function displays the data visible on the main screen. Zoom function affects amount of displayed data.**

---

The cursors' position information are displayed in lower right corner of the window:

- - voltage between red vertical cursor and 0V
- ↔ - voltage between vertical cursors
- ↑ - voltage between red horizontal cursor and 0V
- ↕ - voltage between horizontal cursors

“Color” – opens standard operating system dialog, where you can select the shape color

“Save” – saves shape in .jpg format.

“Pause” – pauses shape updating

## 6.9. Fourier transformation function (FT)

The fourier transformation transforms acquired samples using fourier transformation. The FFT (fast fourier transformation) and DFT (discrete fourier transformation) are implemented. In case the automatic period selection is activated, one period of waveform is transformed, otherwise the part distinguished by cursors in oscilloscope software is transformed.

The fourier transformation window is opened after activation of the FT function.

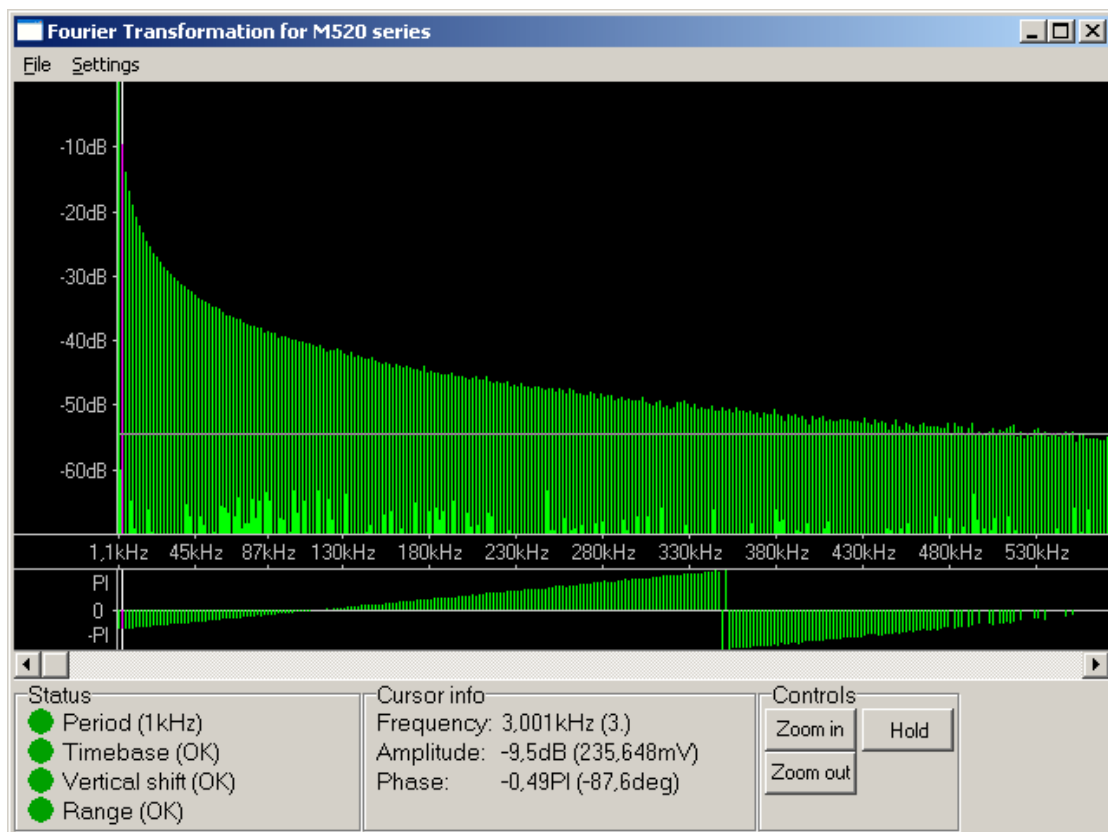

**Figure 6.9.1. – Fourier transformation window**

The main screen is located in the top of the window. The frequency bar divides it into two parts. You can change the parts' size by dragging this bar. The harmonics' amplitude is displayed in the top part (amplitude part), the phase in bottom one.

The threshold amplitude is represented by grey horizontal line in the amplitude part. You can change threshold by dragging this line. Phase is displayed only for the harmonics with amplitude above this threshold.

If the decibels amplitude mode is activated, you can change amplitude range by dragging ticks in the left of the amplitude part.

The watched harmonic can be selected by vertical grey cursor.

You can scroll data using the scroll bar located below main screen.

The status panel with information about analyzed signal is located in the left bottom corner of the main window.

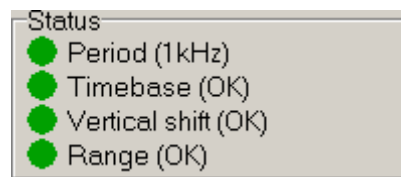

**Figure 6.9.2. – Status panel**

If the indicator „Period“ is:

red – application was not able to find period automatically

green – period found successfully

grey – the manual selection of period is activated

The current selected period is displayed in parentheses.

If the indicator „Timebase“ is:

red, yellow – the timebase is too slow for analyzed signal, faster timebase will produce better results

green – suitable timebase is set

grey – the automatic period selection is deactivated

If the indicator „Vertical shift“ is:

red – vertical shift is not suitable. If the „Up“ is in parentheses, the waveform is shifted up, „Down“ – waveform is shifted down.

green – suitable vertical shift is set.

If the indicator „Range“ is:

red – range is not suitable. If the „Sensitive“ is in parentheses, sensitive range is set, „Insensitive“ – insensitive range is set.

green – suitable range is set.

The information about harmonic selected by cursor are displayed in the bottom of the main window.

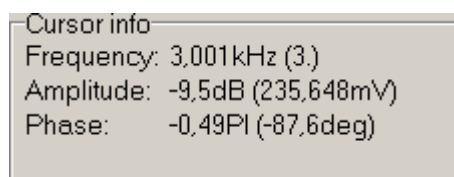

**Figure 6.9.3. – Information about harmonic selected by cursor**

„Frequency“ – Frequency of harmonic (its index)

„Amplitude“ – Amplitude of harmonic in decibels (in voltage)

„Phase“ – Phase of harmonic in radians (in degrees)

---

**TIP: The effective or peak voltage of harmonic can be displayed. You can select it in main menu.**

---

The main screen controls are located in the right bottom corner of the main window.

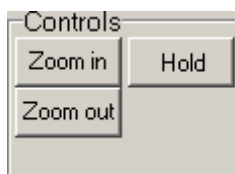

*Figure 6.9.4. – Screen controls*

Click „Hold“ button to pause/unpause data refresh. Click „Zoom in“ to display less data on the screen, click „Zoom out“ to display more.

---

**TIP: You can zoom in/out using mouse wheel: if the mouse cursor is over amplitude part of screen, rotation of wheel from you zooms in, to you zooms out. The position of harmonic below mouse cursor remains intact after zoom (if possible).**

---

### 6.9.1. Main menu

The main menu is located in the top of the window. Following items are available:

*File / Print* – Opens the print manager

*Settings / Data source / Channel A* – Sets channel A as data source

*Settings / Data source / Channel B* – Sets channel B as data source

*Settings / Period selection / Automatic* – Activates automatic period selection

---

**WARNING: Automatic period selection can fail to find period of some signals. If you are not sure, whether found period is correct, select period by cursors and activate one of manual modes.**

---

*Settings / Period selection / Manual with fine shift* – The period selected by cursors are automatically adjusted to match period. The period is adjusted maximally by  $\pm 2$  points of scope screen.

---

**TIP: Manual mode with fine shift is suitable if you need to select signal period longer than 500 samples. It is not possible to select period with precision of one sample in manual mode if there is more than 500 samples on the oscilloscope screen.**

---

*Settings / Period selection / Manual* – The period is selected by vertical cursors

---

**WARNING: It is not possible to select period with precision of one sample in manual mode if there is more than 500 samples on the oscilloscope screen, because one screen point corresponds with more than one acquired sample. The manual mode with fine shift is suitable for most measurements.**

---



---

**TIP: The more samples will be period composed of, the more precise results will be achieved.**

---

*Settings / Algorithm / FFT* – Data will be transformed by fast fourier transformation.

*Settings / Algorithm / DFT* – Data will be transformed by discrete fourier transformation.

---

**TIP: The FFT is suitable for most measurements. DFT is suitable for extremely high precise measurements only: FFT with very high quality is essentially same as DFT.**

---

*Settings / FFT quality / Normal* – Sets normal FFT quality. This quality distorts harmonics near half of sampling frequency.

*Settings / FFT quality / High* - Sets high FFT quality. This quality little distorts harmonics near half of sampling frequency.

*Settings / FFT quality / Very high* – Sets very high FFT quality. The result is essentially same as it were transformed using DFT.

---

**WARNING: FFT with normal quality lowers amplitude of harmonics near half of sampling frequency. We do recommend to use DFT for precise measurements of these frequencies (or FFT with very high quality, if fast transformation is desired).**

---

*Settings / Amplitude mode / Decibels* – Displays harmonics' amplitudes in logarithmic mode, where 0dB is amplitude of harmonic with the highest energy.

*Settings / Amplitude mode / Voltage* – Displays harmonics' amplitudes in linear mode in voltage.

*Settings / Voltage mode / Amplitude* – Voltage will represent amplitude of harmonic.

*Settings / Voltage mode / Effective* – Voltage will represent effective voltage of harmonic.

*Settings / Stay on top* – Activates/deactivates always on top mode of main window.

Following items control inverse fourier transformation (IFT). It is necessary to activate IFT to use them.

*Filter / Mode / Surpress noise* – The harmonics with level higher than the threshold will be used for inverse fourier transformation.

*Filter / Mode / Simple* – Inverse fourier transformation is calculated from selected harmonics. Hold ctrl and click on harmonics to select/deselect it. Hold shift and double click on screen to select/deselect all harmonics.

*Filter / Mode / Complex* – The harmonics are modified by filter specified before IFT calculation. Therefore, the result represents the input waveform pass through specified filter. You can specify filter by clicking on the item in main menu.

*Filter / Algorithm / FFT* – Data will be transformed by inverse fast fourier transformation.

*Filter / Algorithm / DFT* – Data will be transformed by inverse discrete fourier transformation.

---

**WARNING: The inverse FFT algorithm has negative effect on the waveform quality. To achieve best results, use DFT on both transformations (inverse fourier transformation and fourier transformation).**

---

*Filter | FFT Quality | Normal* – Sets normal quality of the inverse FFT.

*Filter | FFT Quality | High* – Sets high quality of the inverse FFT.

*Filter | FFT Quality | Very high* – Sets very high quality of the inverse FFT.

---

**WARNING: Inverse FFT quality settings affect only inverse fourier transformation. Change parameters of the fourier transformation to eliminate errors caused by the fourier transformation.**

---

*Filter | Configure complex filter* – Opens the configure complex filter window.

## 6.9.2. Complex filter window

The complex filter window is opened after click on the main menu item.

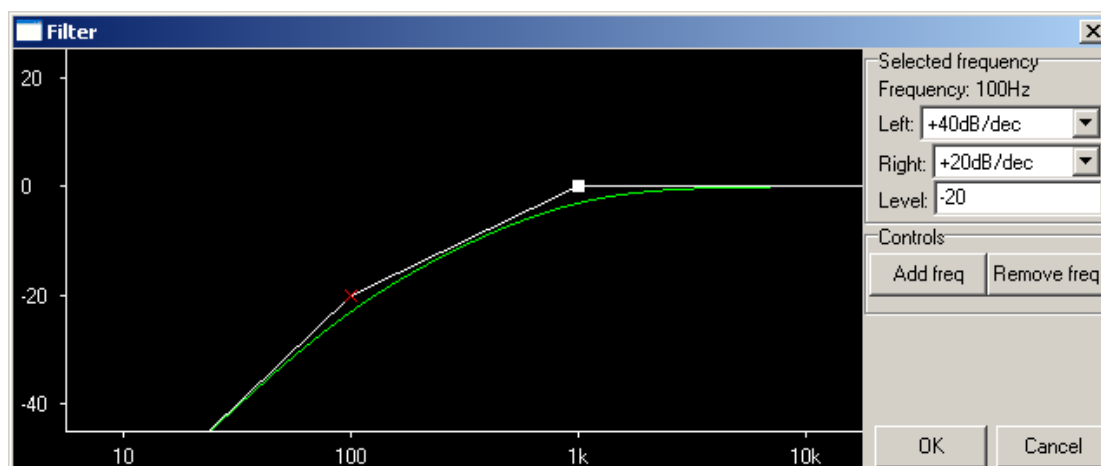

*Figure 6.9.2.1. – Complex filter window*

The filter graph is displayed in the left part of the window. Cut frequencies are marked by a cross or square. Software composes real filter from RC filters with specified cut frequencies. Real filter is displayed in green.

Cut frequency marked by cross has its level fixed. Other frequencies' levels (marked by square) are calculated from fixed frequency level.

Click cross or square to selected cut frequency. Selected cut frequency is displayed in red.

The selected frequency controls are located in right of the window.



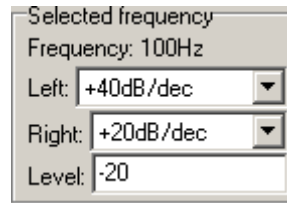
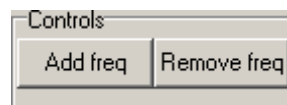

**Figure 6.9.2.2. – Selected frequency controls**

Click „left“ combobox to change filter steepness below selected frequency, click „right“ combobox to change filter steepness above selected frequency.

It is possible to set attenuation at specified frequency in „level“ edit box. The frequency's level become fixed after this operation.

Frequencies controls are located in the bottom left corner of the window.



**Figure 6.9.2.3. – Frequencies controls**

Click „Remove freq“ button to delete selected frequency.

Click „Add freq“ button to open a window, where you can select new cut frequency.

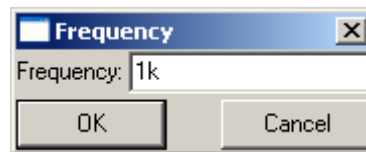

**Figure 6.9.2.4. – New frequency window**

It is necessary to enter desired frequency into „Frequency“ edit box.

---

**TIP: It is possible to enter value into „Frequency“ edit box with power of ten (for example 1k = 1000). It is possible to use k – kilo and M – mega.**

---

## 6.10. Multiwave function (MW)

Multiwave function displays waveform history together with probability of sample occurrence.

The multiwave window opens after function activation.

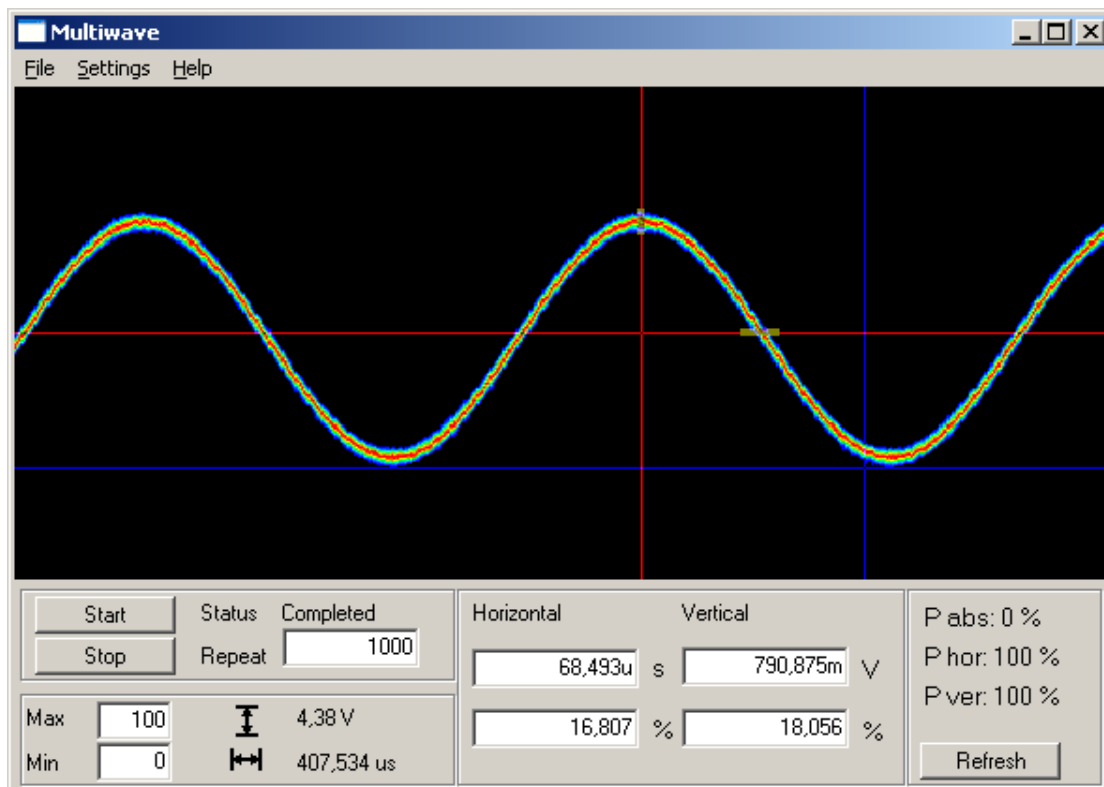

**Figure 6.10.1. – Multiwave function window**

The waveform part displayed in the top of the window corresponds with part in application. The occurrence probabilities are displayed depending on selected mode:

1. Monochromatic – The sample with zero probability is displayed in black. Others are shaded in blue (most probable with light blue).

2. Color – The sample with zero probability is displayed in black. Others are, from most improbable, displayed in dark blue, light blue, dark green, light green, dark red and light red.

3. Multiwave – The sample with zero probability is displayed in black. Others are displayed in channel color.

Pair of horizontal (red and blue) and vertical (red and blue) cursors is displayed in the main screen. Each red cursor is linked with rectangle, which allows you to select part of pixels (slice). It is possible to change the slice size.

---

**TIP: You can drag both vertical and horizontal cursor by dragging their intersection.**

---

The panel 1 is located in the left bottom corner of the window.

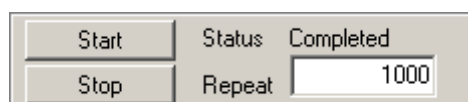

**Figure 6.10.2. – Panel 1**

Click „Start“ button to start acquisition. Click „Stop“ button to terminate it.

Enter value to the indicator located in the right to change the amount of analyzed waveforms.

---

**TIP: The more waveforms are analyzed, the more time it takes. However the results are more accurate.**

---

The acquisition state is displayed in the right of the panel.

The panel 2 is located in the right bottom corner of the window.

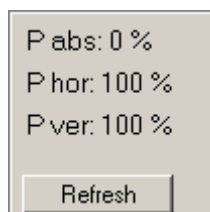

**Figure 6.10.3. – Panel 2**

Following information are displayed in the panel:

P abs or P rel – probability of the occurrence of the sample at the intersection of the red cursors. This probability is calculated as follows:

- the number of occurrences divided by the number of data acquisition count, when in absolute probability mode

- the number of occurrences divided by an maximal occurrence count in that time, when in relative probability mode

P hor – probability of the samples occurrence with level specified by horizontal cursor and time period specified by horizontal slice, where the part specified by vertical cursors are considered to be 100%

P ver – probability of the samples occurrence in time specified by vertical cursor and level specified by vertical slice

Click „Refresh“ to force data redraw.

---

**TIP: During the acquisition process, the data are updated at 20, 40, 60, 80 and 100%.**

---

The panel 3 is located in the left bottom corner.

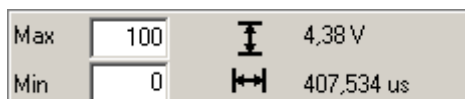

**Figure 6.10.4. – Panel 3**

Enter the value into „Max“ and „Min“ indicator to select the interval of samples probability to be displayed. The samples out of interval will be drawn with the black color.

 - voltage between horizontal cursors

 - time between vertical cursors

The panel 4 is located in the bottom of the window.

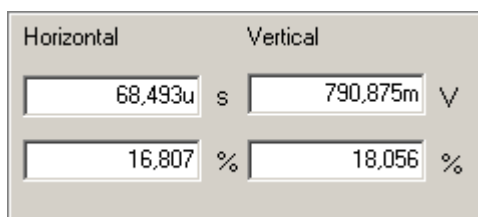

**Figure 6.10.5. – Panel 4**

The horizontal slice controls are located in the left of the panel.

Upper indicator contains length of horizontal slice in seconds, lower one specifies length in percents of the time between vertical cursors.

The vertical slice controls are located in the right of the panel.

Upper indicator contains length of vertical slice in volts, lower one specifies length in percents of the voltage between horizontal cursors.

---

**TIP: It is possible to enter the unit (m – milli, u – micro, n – nano) while entering the time or voltage.**

---

### 6.10.1. Main menu

The main menu is located in the top of the main window. Following items are available:

*File / Print* – Opens the print manager

*File / Save as bitmap* – Saves main screen image into specified file

*File / Exit* – Exits from function

*Settings / Input selector / Top layer / Channel A* – Displays channel A as top layer

*Settings / Input selector / Top layer / Channel B* – Displays channel B as top layer

*Settings / Input selector / Top layer / Channel C* – Displays channel C as top layer

*Settings / Input selector / Top layer / Channel D* – Displays channel D as top layer

*Settings / Input selector / Bottom layer / Channel A* – Displays channel A as bottom layer

*Settings / Input selector / Bottom layer / Channel B* – Displays channel B as bottom layer

*Settings / Input selector / Bottom layer / Channel C* – Displays channel C as bottom layer

*Settings / Input selector / Bottom layer / Channel D* – Displays channel D as bottom layer

*Settings / Input selector / Single layer* – Displays only top layer

---

**TIP: If you select as top layer the same channel as is selected as bottom layer, the channel assignments “swaps”: The channel that was assigned to top layer will be assigned to bottom one and vice-versa.**

---

*Settings / Probability mode / Absolute* – Activates absolute probability mode

*Settings / Probability mode / Relative* – Activates relative probability mode

---

**WARNING: The probability mode has no influence on other information than P abs or P rel.**

---

*Settings / Stay on top* – Activates/deactivates always on top mode of main window

*Settings / Color mode / Monochromatic* – Activates monochromatic display mode

*Settings / Color mode / Color* – Activates color display mode

*Settings / Color mode / Multiwave* – Activates multiwave display mode

---

**TIP: Selection of proper display mode can ease the measurement. You can find detail description of each mode at the beginning of the chapter 6.10.**

---

*Help / Help* – opens the help in html format

## 6.11. Inverse fourier transformation function (IFT)

This function calculates inverse fourier transformation from the data calculated by fourier transformation module (FT).

---

**WARNING: You can use this function only together with FT function. If the FT function is not activated, it is not possible to activate IFT function.**

---

All IFT settings are accessible through FT module's main menu.

## 6.12. Waveform parameters function (Wp)

Waveform parameters function calculates parameters of the channel A, B, C or D waveform.

The window opens after module activation.

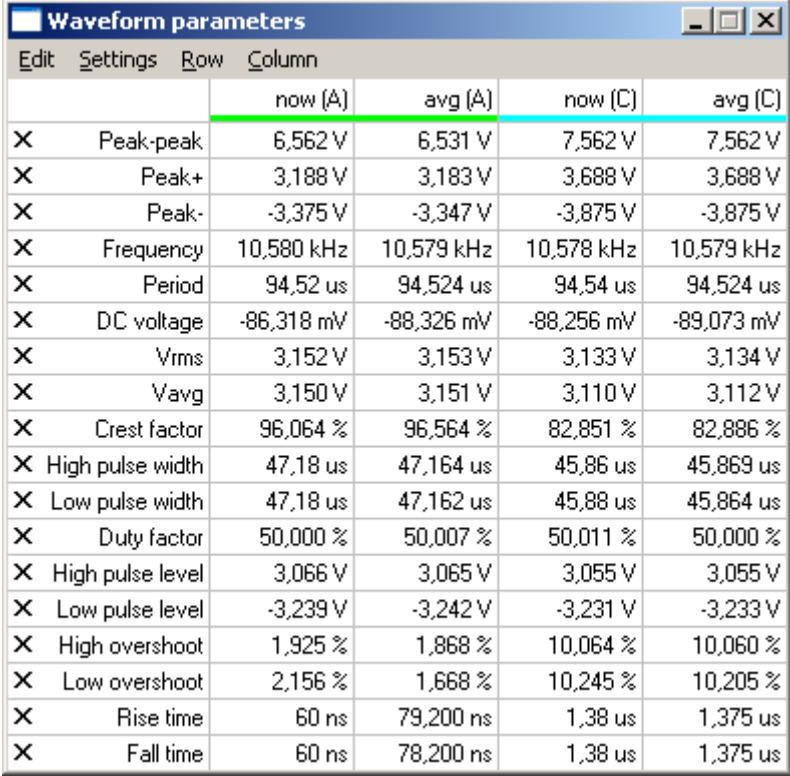

		now (A)	avg (A)	now (C)	avg (C)
X	Peak-peak	6,562 V	6,531 V	7,562 V	7,562 V
X	Peak+	3,188 V	3,183 V	3,688 V	3,688 V
X	Peak-	-3,375 V	-3,347 V	-3,875 V	-3,875 V
X	Frequency	10,580 kHz	10,579 kHz	10,578 kHz	10,579 kHz
X	Period	94,52 us	94,524 us	94,54 us	94,524 us
X	DC voltage	-86,318 mV	-88,326 mV	-88,256 mV	-89,073 mV
X	Vrms	3,152 V	3,153 V	3,133 V	3,134 V
X	Vavg	3,150 V	3,151 V	3,110 V	3,112 V
X	Crest factor	96,064 %	96,564 %	82,851 %	82,886 %
X	High pulse width	47,18 us	47,164 us	45,86 us	45,869 us
X	Low pulse width	47,18 us	47,162 us	45,88 us	45,864 us
X	Duty factor	50,000 %	50,007 %	50,011 %	50,000 %
X	High pulse level	3,066 V	3,065 V	3,055 V	3,055 V
X	Low pulse level	-3,239 V	-3,242 V	-3,231 V	-3,233 V
X	High overshoot	1,925 %	1,868 %	10,064 %	10,060 %
X	Low overshoot	2,156 %	1,668 %	10,245 %	10,205 %
X	Rise time	60 ns	79,200 ns	1,38 us	1,375 us
X	Fall time	60 ns	78,200 ns	1,38 us	1,375 us

**Figure 6.12.1. – Waveform parameters window**

Following parameters are displayed in the table:

- „Peak-peak“ – peak-peak voltage
- „Peak+“ – voltage of the maximum
- „Peak-“, – voltage of the minimum
- „Frequency“ – frequency
- „Period“ – period
- „DC voltage“ – DC voltage
- „Vrms“ – effective voltage
- „Vavg“ – average voltage
- „Crest factor“ – crest factor

If the module fails to detect periodicity of the waveform, „N/A“ is displayed in the place of „Frequency“, „Period“, „DC voltage“, „Vrms“, „Vavg“, „Crest factor“.

- „High pulse width“ – high pulse width
- „Low pulse width“ – low pulse width
- „Duty factor“ – duty factor
- „High pulse level“ – level of the high pulse
- „Low pulse level“ – level of the low pulse
- „High overshoot“ – overshoot of the leading edge
- „Low overshoot“ – overshoot of the trailing edge
- „Rise time“ – length of the leading edge
- „Fall time“ – length of the trailing edge

If the module fails to detect periodicity or rectangular shape of the waveform, „N/A“ is displayed in the place of „High pulse width“, „Low pulse width“, „Duty

factor“, „High pulse level“, „Low pulse level“, „High overshoot“, „Low overshoot“, „Rise time“, „Fall time“.

Time between 10% and 90% of the voltage between low and high pulse is considered to be length of the edge.

Click cross at the left side of the parameter name to hide it.

It is possible to display following statistics for each parameter:

- „now“ – current value of the parameter
- „min“ – minimal value of the parameter
- „max“ – maximal value of the parameter
- „avg“ – average value of the parameter
- „dev“ – parameter deviation

---

**WARNING: The statistics are calculated from whole history of the waveform. Click item in main menu to reset them.**

---

### 6.12.1. – Main menu

Main menu is located in top of the window. Following items are available:

*Edit / Copy* – Copies table to clipboard in text format.

*Edit / Reset params* – Resets statistics of all parameters.

*Settings / Channel C range source* – Channel C parameters will be calculated using range of selected channel.

*Settings / Channel D range source* – Channel D parameters will be calculated using range of selected channel

*Settings / Stay on top* – Activates/deactivates mode always on top mode of the window.

*Row / Show* – Shows/hides selected parameter

*Row / Show only* – Shows selected parameters and hides others.

*Row / Show all* – Shows all parameters

*Row / Configure rows* – Opens the window, where it is possible to show/hide parameters.

*Column / Channel* – Activates/deactivates selected channel parameters

*Column / Show* – Shows/hides selected statistic

*Column / Show only* – Shows selected statistic and hides others.

*Column / Show all* – Shows all statistics.

*Column / Configure columns* – Opens the window, where it is possible to activate/deactivate channels and show/hide statistics.

## 7. Performance characteristics

### 7.1. Vertical deflection system

No of divisions	8	
No of pixels per division	32	
Deflection factor range	10mV/div to 5V/div in 1-2-5 sequence	
Accuracy	+- 2% of current value + 1 pixel	
Resolution	8 bits (0,39%)	
Frequency response (-3dB)	M521, M522 M523, M524	DC: 0 - 60 MHz, AC: 1.2 Hz - 60 MHz DC: 0 - 120 MHz, AC: 1.2Hz – 120 MHz
Step response rise time	M521, M522 M523, M524	max. 5.8 ns max 2.9 ns
Channel isolation	min. -75 dB	
Resistance	1 MOhm +5 %, -2 %	
Input resistance inaccuracy adjustment	Digital for absolute accuracy +- 2% of current voltage + 1 pixel	
Capacitance	30 pF +- 1pF	
Zero setting accuracy	+- 2% of the screen	
Maximum input voltage	+- 200V at 100 kHz or less	

**Table 7.1.1. – Vertical deflection system**

### 7.2. Triggering

System type	Dual level
Trigger source for primary level	selectable Channel A, Channel B or external trigger input
Trigger source for secondary level	selectable Channel A, Channel B or external trigger input
Threshold setting	Channel A and Channel B on the whole display range. External fixed on about 1.5V
Slope selection	Leading or trailing edge independently on each source
Minimum trigger pulse period	5 ns
Minimum trigger pulse length	2.5 ns
Maximum voltage on external trigger input	-10V to +13V at 20 kHz or less
Adjustments	Digital filter with ability of setting the valid pulse length up to 131072*Ts for each level and counter of valid triggering events settable from 1 to 32768 for each level. HOLD-OFF settable up to 131072*Ts with selectable AUTO mode, to sample proper amount of data before trigger. (Ts – actual real time sampling period)

**Table 7.2.1. – Triggering**



### 7.3. Data acquisition system

No of divisions	10	
No of pixels per division	50	
Mode of operation	Sampling before and after trigger with continual selection of the trigger position	
Record length	M521, M523	4096 samples for each channel
	M522, M524	8192 samples for each channel
Time base range in 1:1 mode	M521, M522	10 ns/d to 50 ms/d in 1-2-5 sequence
	M523, M524	5 ns/d to 50 ms/d in 1-2-5 sequence
Time base range using different ZOOM modes	M521	1 ns/d to 400 ms/d
	M522	1 ns/d to 800 ms/d
	M523	500 ps/d to 400 ms/d
	M524	500 ps/d to 800 ms/d
Time base accuracy	0.01 % to 100ns/d, 0.5 % for 50ns/d to 5 ns/d	
Real time sampling frequency	M521, M522	1kHz to 50 MHz
	M523, M524	1kHz to 100 MHz
Equivalent sampling frequency	M521, M522	1kHz to 5 GHz
	M523, M524	1kHz to 10 GHz
Display range with respect to trigger event	M521, M523	4094 samples before and 63000 samples after trig. event in length of 4096 samples
	M522, M524	8190 samples before and 63000 samples after trig. event in length of 8192 samples

*Table 7.3.1. – Data acquisition system*

### 7.4. Probe compensation generator

Output connector	BNC, together with External trigger input
Output impedance	1 kOhm to parallel with 10nF and approx. 50 Ohm serial
Output waveform	Pulse with 1:1 duty cycle
Frequency	1465 Hz
Output voltage (no load)	3.3V +- 5%

*Table 7.4.1. – Compensation generator*

### 7.5. Power

Power source	USB interface via USB cable
Max current	USB1.1 – 350mA; USB2.0 – 450mA

*Table 7.5.1. - Power*

### 7.6. Mechanical characteristics

Dimensions without feet and connectors	165 x 111 x 35 mm
Dimensions with feet and connectors	182 x 111 x 39 mm
Weight	520 g

*Table 7.6.1. – Mechanical characteristics*

## 7.7. M521 timebase ranges

No	REAL TIME	t/div 1:8	t/div 1:1	t/div 10:1	ACQ. TIME	SAMP. PERIOD	SAMP. FREQ.
2	no	80ns	10ns	1ns	8.196us	200ps	5GHz
3	no	160ns	20ns	2ns	1.638us	400ps	2.5GHz
4	no	400ns	50ns	5ns	4.096us	1n	1GHz
5	no	800ns	100ns	10ns	8.192us	2n	500MHz
6	no	1.6us	200ns	20ns	16.38us	4ns	250MHz
7	no	4us	500ns	50ns	40.96us	10ns	100MHz
8	yes	8us	1us	100ns	81.96us	20ns	50MHz
9	yes	16us	2us	200ns	163.8us	40ns	25MHz
10	yes	40us	5us	500ns	409.6us	100ns	10MHz
11	yes	80us	10us	1us	819.2us	200ns	5MHz
12	yes	160us	20us	2us	1.638ms	400ns	2.5MHz
13	yes	400us	50us	5us	4.096ms	1us	1MHz
14	yes	800us	100us	10us	8.192ms	2us	500kHz
15	yes	1.6ms	200us	20us	16.38ms	4us	250kHz
16	yes	4ms	500us	50us	40.96ms	10us	100kHz
17	yes	8ms	1ms	100us	81.92ms	20us	50kHz
18	yes	16ms	2ms	200us	163.8ms	40us	25kHz
19	yes	40ms	5ms	500us	409.6ms	100us	10kHz
20	yes	80ms	10ms	1ms	819.2ms	200us	5kHz
21	yes	160ms	20ms	2ms	1.638s	400us	2.5kHz
22	yes	400ms	50ms	5ms	4.096s	1ms	1kHz
23	yes	800ms	100ms	10ms	8.192s	2ms	500Hz

*Table 7.7.1. – M521 timebase ranges*

## 7.8. M522 timebase ranges

No	REAL TIME	t/div 1:16	t/div 1:1	t/div 10:1	ACQ. TIME	SAMP. PERIOD	SAMP. FREQ.
2	no	160ns	10ns	1ns	1.638us	200ps	5GHz
3	no	320ns	20ns	2ns	3.276us	400ps	2.5GHz
4	no	800ns	50ns	5ns	8.192us	1n	1GHz
5	no	1.6us	100ns	10ns	16.38us	2n	500MHz
6	no	3.2us	200ns	20ns	32.76us	4ns	250MHz
7	no	8us	500ns	50ns	81.92us	10ns	100MHz
8	yes	16us	1us	100ns	163.8us	20ns	50MHz
9	yes	32us	2us	200ns	327.6us	40ns	25MHz
10	yes	80us	5us	500ns	819.2us	100ns	10MHz
11	yes	160us	10us	1us	1.638ms	200ns	5MHz
12	yes	320us	20us	2us	3.276ms	400ns	2.5MHz
13	yes	800us	50us	5us	8.192ms	1us	1MHz
14	yes	1.6ms	100us	10us	16.38ms	2us	500kHz
15	yes	3.2ms	200us	20us	32.76ms	4us	250kHz
16	yes	8ms	500us	50us	81.92ms	10us	100kHz
17	yes	16ms	1ms	100us	163.8ms	20us	50kHz

18	yes	32ms	2ms	200us	327.6ms	40us	25kHz
19	yes	80ms	5ms	500us	819.2ms	100us	10kHz
20	yes	160ms	10ms	1ms	1.638s	200us	5kHz
21	yes	320ms	20ms	2ms	3.276s	400us	2.5kHz
22	yes	800ms	50ms	5ms	8.192s	1ms	1kHz
23	yes	1.6s	100ms	10ms	16.384s	2ms	500Hz

*Table 7.8.1. – M522 timebase ranges***7.9. M523 timebase ranges**

No	REAL TIME	t/div 1:8	t/div 1:1	t/div 10:1	ACQ. TIME	SAMP. PERIOD	SAMP. FREQ.
1	no	40ns	5ns	500ps	409.6ns	100ps	10GHz
2	no	80ns	10ns	1ns	8.196us	200ps	5GHz
3	no	160ns	20ns	2ns	1.638us	400ps	2.5GHz
4	no	400ns	50ns	5ns	4.096us	1n	1GHz
5	no	800ns	100ns	10ns	8.192us	2n	500MHz
6	no	1.6us	200ns	20ns	16.38us	4ns	250MHz
7	yes	4us	500ns	50ns	40.96us	10ns	100MHz
8	yes	8us	1us	100ns	81.96us	20ns	50MHz
9	yes	16us	2us	200ns	163.8us	40ns	25MHz
10	yes	40us	5us	500ns	409.6us	100ns	10MHz
11	yes	80us	10us	1us	819.2us	200ns	5MHz
12	yes	160us	20us	2us	1.638ms	400ns	2.5MHz
13	yes	400us	50us	5us	4.096ms	1us	1MHz
14	yes	800us	100us	10us	8.192ms	2us	500kHz
15	yes	1.6ms	200us	20us	16.38ms	4us	250kHz
16	yes	4ms	500us	50us	40.96ms	10us	100kHz
17	yes	8ms	1ms	100us	81.92ms	20us	50kHz
18	yes	16ms	2ms	200us	163.8ms	40us	25kHz
19	yes	40ms	5ms	500us	409.6ms	100us	10kHz
20	yes	80ms	10ms	1ms	819.2ms	200us	5kHz
21	yes	160ms	20ms	2ms	1.638s	400us	2.5kHz
22	yes	400ms	50ms	5ms	4.096s	1ms	1kHz
23	yes	800ms	100ms	10ms	8.192s	2ms	500Hz

*Table 7.9.1. – M523 timebase ranges***7.10. M524 timebase ranges**

No	REAL TIME	t/div 1:16	t/div 1:1	t/div 10:1	ACQ. TIME	SAMP. PERIOD	SAMP. FREQ.
1	no	80ns	5ns	500ps	819.2us	100ps	10GHz
2	no	160ns	10ns	1ns	1.638us	200ps	5GHz
3	no	320ns	20ns	2ns	3.276us	400ps	2.5GHz
4	no	800ns	50ns	5ns	8.192us	1n	1GHz
5	no	1.6us	100ns	10ns	16.38us	2n	500MHz
6	no	3.2us	200ns	20ns	32.76us	4ns	250MHz
7	yes	8us	500ns	50ns	81.92us	10ns	100MHz

8	yes	16us	1us	100ns	163.8us	20ns	50MHz
9	yes	32us	2us	200ns	327.6us	40ns	25MHz
10	yes	80us	5us	500ns	819.2us	100ns	10MHz
11	yes	160us	10us	1us	1.638ms	200ns	5MHz
12	yes	320us	20us	2us	3.276ms	400ns	2.5MHz
13	yes	800us	50us	5us	8.192ms	1us	1MHz
14	yes	1.6ms	100us	10us	16.38ms	2us	500kHz
15	yes	3.2ms	200us	20us	32.76ms	4us	250kHz
16	yes	8ms	500us	50us	81.92ms	10us	100kHz
17	yes	16ms	1ms	100us	163.8ms	20us	50kHz
18	yes	32ms	2ms	200us	327.6ms	40us	25kHz
19	yes	80ms	5ms	500us	819.2ms	100us	10kHz
20	yes	160ms	10ms	1ms	1.638s	200us	5kHz
21	yes	320ms	20ms	2ms	3.276s	400us	2.5kHz
22	yes	800ms	50ms	5ms	8.192s	1ms	1kHz
23	yes	1.6s	100ms	10ms	16.384s	2ms	500Hz

*Table 7.10.1. – M524 timebase ranges***7.11. M525 timebase ranges**

No	REAL TIME	t/div 1:10	t/div 1:1	t/div 10:1	ACQ. TIME	SAMP. PERIOD	SAMP. FREQ.
1	no	20ns	2ns	200ps	204.8ns	50ps	20GHz
2	no	50ns	5ns	500ps	512ns	125ps	8GHz
3	no	100ns	10ns	1ns	1.024us	250ps	4GHz
4	no	200ns	20ns	2ns	2.048us	500ps	2GHz
5	no	500ns	50ns	5ns	5.12us	1.25ns	800MHz
6	no	1us	100ns	10ns	10.24us	2.5ns	400MHz
7	yes	2us	200ns	20ns	20.48us	5ns	200MHz
8	yes	5us	500ns	50ns	51.2us	12.5ns	80MHz
9	yes	10us	1us	100ns	102.4us	25ns	40MHz
10	yes	20us	2us	200ns	204.8us	50ns	20MHz
11	yes	50us	5us	500ns	512ms	125ns	8MHz
12	yes	100us	10us	1us	1.024ms	250ns	4MHz
13	yes	200us	20us	2us	2.048ms	500ns	2MHz
14	yes	500us	50us	5us	5.12ms	1.25us	800kHz
15	yes	1ms	100us	10us	10.24ms	2.5us	400kHz
16	yes	2ms	200us	20us	20.48ms	5us	200kHz
17	yes	5ms	500us	50us	51.2ms	12.5us	80kHz
18	yes	10ms	1ms	100us	102.4ms	25us	40kHz
19	yes	20ms	2ms	200us	204.8ms	50us	20kHz
20	yes	50ms	5ms	500us	512ms	125us	8kHz
21	yes	100ms	10ms	1ms	1.024s	250us	4kHz
22	yes	200ms	20ms	2ms	4.096s	500us	2kHz
23	yes	500ms	50ms	5ms	10.24s	1.25ms	800Hz
24	yes	1s	100ms	10ms	20.48s	2.5ms	400Hz

*Table 7.11.1. – M525 timebase ranges*

**7.12. M526 timebase ranges**

No	REAL TIME	t/div 1:20	t/div 1:1	t/div 10:1	ACQ. TIME	SAMP. PERIOD	SAMP. FREQ.
1	no	40ns	2ns	200ps	409.6ns	50ps	20GHz
2	no	100ns	5ns	500ps	1.024us	125ps	8GHz
3	no	200ns	10ns	1ns	2.048us	250ps	4GHz
4	no	400ns	20ns	2ns	4.096us	500ps	2GHz
5	no	1us	50ns	5ns	10.24us	1.25ns	800MHz
6	no	2us	100ns	10ns	20.48us	2.5ns	400MHz
7	yes	4us	200ns	20ns	40.96us	5ns	200MHz
8	yes	10us	500ns	50ns	102.4us	12.5ns	80MHz
9	yes	20us	1us	100ns	204.8us	25ns	40MHz
10	yes	40us	2us	200ns	409.6us	50ns	20MHz
11	yes	100us	5us	500ns	1.024ms	125ns	8MHz
12	yes	200us	10us	1us	2.048ms	250ns	4MHz
13	yes	400us	20us	2us	4.096ms	500ns	2MHz
14	yes	1ms	50us	5us	10.24ms	1.25us	800kHz
15	yes	2ms	100us	10us	20.48ms	2.5us	400kHz
16	yes	4ms	200us	20us	40.96ms	5us	200kHz
17	yes	10ms	500us	50us	102.4ms	12.5us	80kHz
18	yes	20ms	1ms	100us	204.8ms	25us	40kHz
19	yes	40ms	2ms	200us	409.6ms	50us	20kHz
20	yes	100ms	5ms	500us	1.024s	125us	8kHz
21	yes	200ms	10ms	1ms	2.048s	250us	4kHz
22	yes	400ms	20ms	2ms	4.096s	500us	2kHz
23	yes	1s	50ms	5ms	10.24s	1.25ms	800Hz
24	yes	2s	100ms	10ms	20.48s	2.5ms	400Hz

*Table 7.12.1. – M526 timebase ranges*